



CLASSIC  
GLAMOUR  
PHOTOGRAPHY

TECHNIQUES OF THE TOP GLAMOUR PHOTOGRAPHERS

DUNCAN EVANS • IAIN BANKS  
REVISED EDITION

# **CLASSIC GLAMOUR PHOTOGRAPHY**





# CLASSIC GLAMOUR PHOTOGRAPHY

Duncan Evans • Iain Banks



Argentum

A QUARTO BOOK

Copyright © 2003 Quarto plc

First published in the United Kingdom in 2003  
by Argentum  
an imprint of Aurum Press Limited  
25 Bedford Avenue  
London  
WC1B 3AT

All rights reserved. No part of this publication may be reproduced or used in any form or by any means – graphic, electronic, or mechanical, including photography, recording, taping, or information-storage-and-retrieval systems – without the written permission of the copyright holder.

ISBN: 1-902538-31-5

A catalogue copy of this book is available from the British Library

QUAR.AGP2

Conceived, designed, and produced by  
Quarto Publishing plc  
The Old Brewery  
6 Blundell Street  
London N7 9BH

Editors: Alice Tyler, Kate Tuckett  
Senior Art Editor: Penny Cobb  
Designer: Ross George  
Illustrator: Kuo Kang Chen  
Proofreader: Claire Waite Brown  
Indexer: Diana Le Core

Art Director: Moira Clinch  
Publisher: Piers Spence

Manufactured by Universal Graphics (Pte) Ltd.,  
Singapore  
Printed by Leefung-Asco Printers Ltd., China

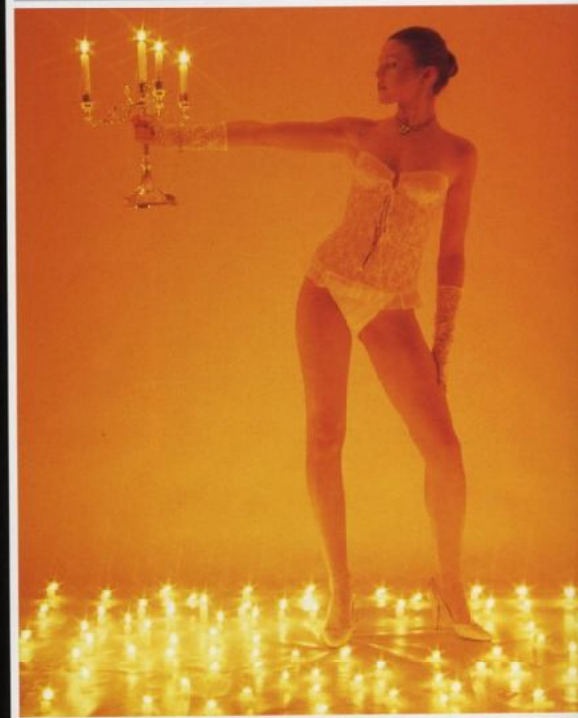

# CONTENTS

FOREWORD 6

## SECTION ONE: THE CLASSIC PHOTOGRAPHERS 8

CLIVE AUSTIN 10  
BOB CARLOS CLARKE 14  
LUCIEN CLERGUE 18  
JAN COBB 22  
EMMA DELVES-BROUGHTON 26  
ROBERT FARBER 32  
NIGEL HOLMES 36  
CHAS RAY KRIDER 42  
ERIC KROLL 46  
PATRICK LICHFIELD 52  
CRAIG MOREY 56  
TREVOR WATSON 62  
BEN WESTWOOD 68  
TREVOR AND FAYE YERBURY 72

## SECTION TWO: WORKING PROFESSIONALLY 78

INTRODUCTION 80  
PHOTOGRAPHIC EQUIPMENT: CAMERAS 88  
PHOTOGRAPHIC EQUIPMENT: LENSES 92  
PHOTOGRAPHIC EQUIPMENT: FILM 96  
PHOTOGRAPHIC EQUIPMENT: ACCESSORIES 98  
LIGHTING CONDITIONS 108  
SHOOTING IN A STUDIO 124  
SHOOTING ON LOCATION 128  
COMPOSITION 138  
THE MODEL 148  
POST PRODUCTION 156

INDEX 158

ACKNOWLEDGEMENTS 160

# FOREWORD

*Classic glamour is a phrase that encompasses many disciplines, from the brightly lit and sunny smiles of the tabloid newspaper or calendar girl, to the classic nude by way of the leather-clad fetishist. Classic Glamour Photography focuses on the work taken from a group of photographers whose subjects span these categories and definitions. In interviews with each one, we find out how they came to work in their respective fields and what motivates, drives, and enthuses them. The second section of the book includes everything you need to know about becoming a classic glamour photographer yourself. You can find out about camera equipment—both film and digital, lighting—both natural and studio, and film stock and digital media. There is also a chapter on finding and using models and studios, and the problems and pitfalls of mounting a shoot yourself. The book concludes with a section on post-production techniques using photo-editing software.*

*Apart from equipment, studio space, and models, what separates the great and the good from the ordinary is the ability to see a picture before the first prop is assembled. A creative eye is the most important skill to have, and while technique can be learned through experience, and equipment collected over time, the fact remains that if you don't have a singular vision before picking up the camera, you won't have something memorable by the time you put it down again.*

*Of all the photographers in this book, Robert Farber and Lucien Clergue are the most distinctly artistic purveyors of their art, imbuing a lightness and texture to their photography where form and color reign supreme. Jan Cobb and the Yerburs—Trevor and Faye—produce more modern, but refined and stylized color work, presenting the naked form as a thing of beauty, within carefully considered surroundings. If anything, Cobb has a more minimalist feel that is also taken up by Chas Ray Krider, Eric Kroll, and Craig Morey, but Kroll has more of a foot in the fetish world of restraint and bondage. His images can be darker and more menacing. Trevor Watson also uses shadows and lighting to great effect, within a predominantly black-and-white environment but unlike Kroll and Morey, his photos contain a good deal of subversive humor. As part of the 90s*

*boom in fetish-inspired erotica, Watson can both stimulate and simultaneously entertain. Bob Carlos Clarke is a man whose career and output have been constantly re-invented due to the requirements of advertising clients, where his work is based. Sex is an integral part of his work, at times causing controversy as witnessed in a recent advertising campaign set in a nightclub, pushing the boundaries of what is acceptable in advertising.*

*For classical glamour, the Lichfield shots for the Unipart calendar are synonymous with expensive, stylish settings inhabited by nubile young ladies while a more down-to-earth commercial approach has been employed by Nigel Holmes to fill magazine after magazine with traditional, brightly lit, happy glamour girls. Clive Austin is also a commercial photographer, but uses the internet to help promote his glamour and photography training sessions for models and photographers. Recently, the color work of Ben Westwood and Emma Delves-Broughton, with their inclination toward fetishism but incorporating the bright colors and kitsch style reminiscent of David LaChapelle, has given yet another flavorsome strand to the photographic art of classic glamour. Delves-Broughton also brings the female perspective to what has largely been a male domain.*

*All these people and different styles are represented in this book and I hope that they will inspire you in your own photographic endeavors, or at the very least, present you with an interesting insight into the world of the classic glamour photographer.*

A handwritten signature in white ink, appearing to read 'D. Evans', with a stylized, flowing script.

Duncan Evans



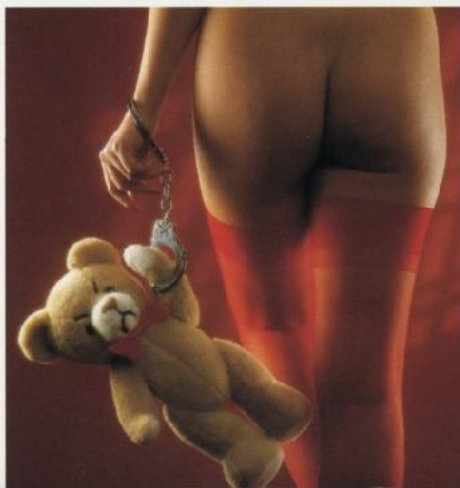
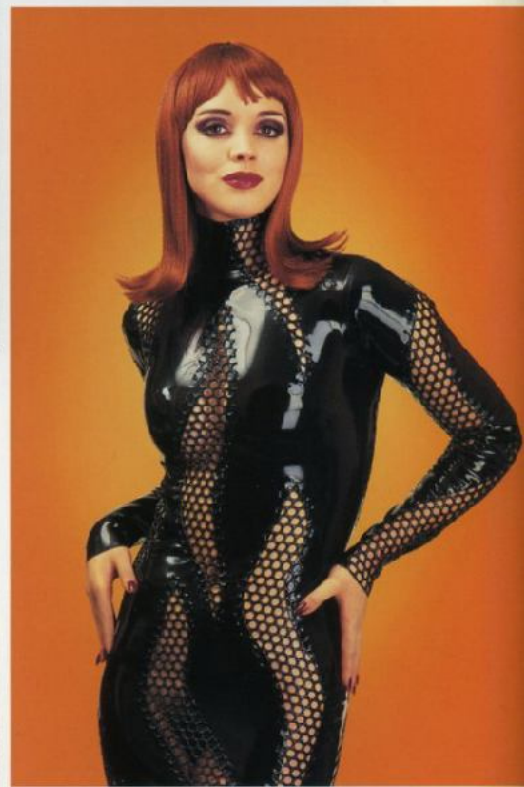
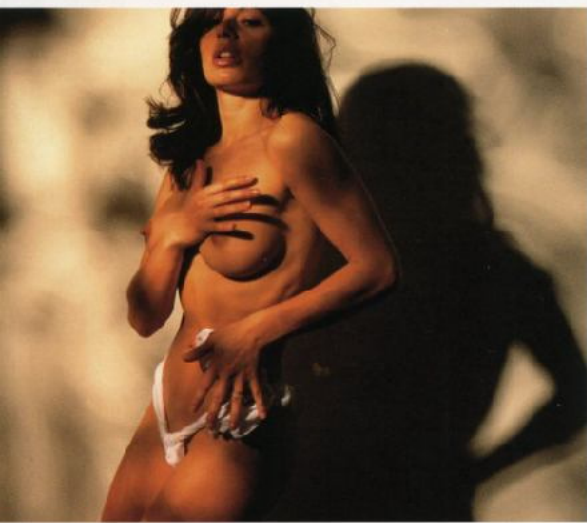

SECTION ONE

***THE CLASSIC PHOTOGRAPHERS***

***10 CLIVE AUSTIN***

***14 BOB CARLOS CLARKE***

***18 LUCIEN CLERGUE***

***22 JAN COBB***

***26 EMMA DELVES-BROUGHTON***

***32 ROBERT FARBER***

***36 NIGEL HOLMES***

***42 CHAS RAY KRIDER***

***46 ERIC KROLL***

***52 PATRICK LICHFIELD***

***56 CRAIG MOREY***

***62 TREVOR WATSON***

***68 BEN WESTWOOD***

***72 TREVOR AND FAYE YERBURY***

# CLIVE AUSTIN

"Digital is the way forward—ease-of-use and no chemical impact on the environment has to be a good thing."

Commercial photographer Clive Austin didn't start out in glamour photography in the time-honored tradition of working in someone else's studio as an assistant or by going to college. He started out by training as an engineer which became his chosen profession until, in 1971, his wife bought him a 35mm Ilford Sportsman camera. He began to teach himself the tricks of the trade, moving on to a Zenith B four years later. This particular camera taught him all about depth of field—with only a preset lens, it meant that you had to manually change the aperture to the required setting after first viewing and composing at full aperture. In 1978 he bought a Nikon F which, although nine years old, ran like silk and was used constantly. Clive then moved up to a Mamiya RB67 in 1984 which he used for most of his model shoots. All the time he was experimenting with light and models. A 5 x 4 in Arca Swiss monorail was added when he moved into his studio in 1989. All his cameras used prime lenses then, but now Clive uses Tokina ATX pro lenses which are zooms—this minimizes the lens changing, which can cause dust to get onto the Charged Coupled Device of his digital kit.

Clive's current studio is in an industrial unit which gives an ideal working height

of 16 ft (5m) as well as a roller-shutter door 10 ft (3m) wide so he can bring in motorbikes. The shooting area is 28 ft (9m) deep by 17 ft (6m) wide, with a wood-laminate floor that he can build sets or roll out coloramas on. Lighting is supplied by Elinchrome, Bowens, and Courtenay flash systems, and he uses softboxes rather than umbrellas for smoother light. He has three boom arms so that he can position lights over and behind models, which is an important feature of Clive's overall photography style. In common with many commercial photographers, Clive has gone completely digital. "We use digital all the time now—a Fuji S1 Pro. The RB67 and the Arca Swiss monorail have been put away. Using software, we can interpolate files up to A0 size and they still look excellent. We have posters of that size on the walls here."

While recent work with the tabloid press adheres to current style and fashion, Clive decries influences but admits to a fondness of Byron Newman's work and, going back to before the war, also says that Wolf Suschitsky produced excellent ideas, as did Man Ray.

Clive's main work is commercial and advertising photography; shooting products (often with models) for advertising agencies and graphic

designers. Usually they want stylish and sexy photography, the combination of which gave Clive one of his most unusual jobs of late. Supadance Ballroom and Latin Shoes of London persuaded a well-known champion dancer to pose near naked while Clive had the task of capturing the scene on camera.

As well as strong lighting and back lighting, body painting is also prevalent in Clive's output. A poster and CD-cover firm commissioned a series of nude photos featuring painted models with striking lighting. "We hire in specialist make-up and body-paint artists for work like this. We love to shoot figure models with super bikes, creating a different look by using a computer to develop a fantasy-style background. Posters of these are selling well to the bike owners who seem to especially like attending during the shoot for some reason!"

He also shoots a lot of portfolios for up-and-coming new models as well as updates for established models—many of which are on his website. In addition, he teaches amateur photographers and sessions have proved very popular. He runs tutorial evenings three to four times a month and all-day tutorials every five to six weeks on a Sunday.

*For this photograph, the background was created by positioning a black venetian blind in front of a painted-sky backdrop, and the sky was lit using flash and blue gels. A spotlight on the right-hand side was then aimed at the model's torso to create the bright strip of light that contrasts so dramatically with the rest of her silhouetted figure.*

28–80mm lens, Fuji S1 digital, 1/125th sec, f8

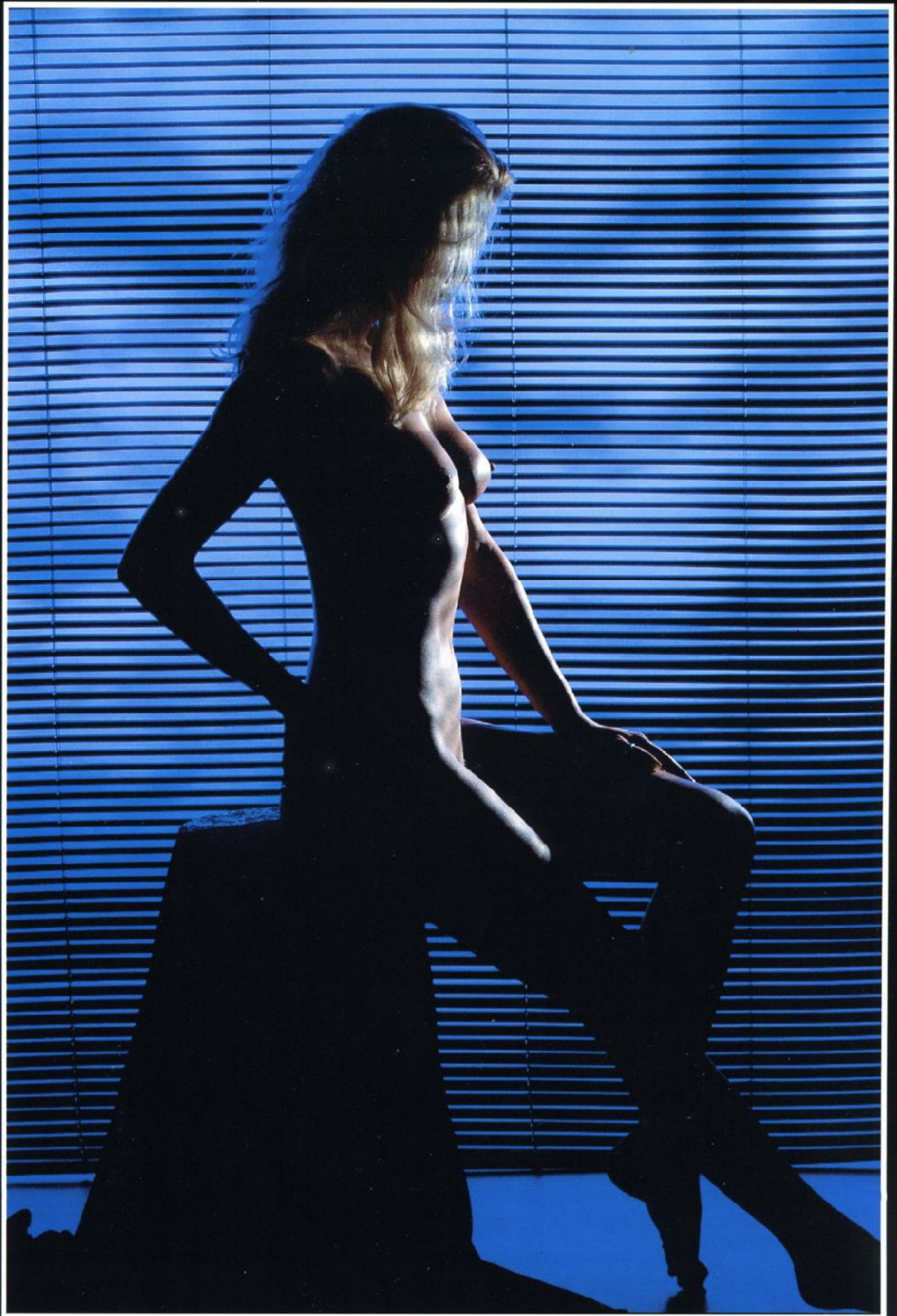



*(Above) This is only the second shot that the model, Sarah, posed nude for. She had been assisting Austin for almost a year when she suddenly asked if he would shoot her in the same way as their models, although she insisted that her face was not to be shown. She loved the result and immediately settled into the idea of being a figure model. This particular shot was taken using a single flash head from above and behind Sarah, creating an incredible, almost mirrored shadow.*  
90mm lens, Kodak EPP 100, 1/60th sec, f8



*(Right) This photograph has been lit with three UV Black Light tubes each 4 ft (just over 1m) long. Two were placed to the right of the camera with the third positioned to the left. The model has been lit with a tungsten light from overhead to create the deep skin tone.*  
28-80mm lens, Fuji S1 digital, 1/10th sec, f4



(Above) This is a composite photograph, which began with the figure shot of the model being rim lit from behind by three flash heads—one each side and one at the top against a black background. The background effect was created by firing the focusing spot down onto silver mirror foil and then photographing the resultant reflection that formed on the wall. The reflection was then rotated by 90 degrees and a copy made and pasted in reverse next to the original. The burst of purple light on the background was created using Micrografx Picture Publisher. Figure shot: 28–80mm lens, Fuji S1 digital, 1/125th sec, f16. Background: 28–80mm lens, Fuji S1 digital, 1/90th sec, f5.6

His studio is called Kaz Studio and the web address is [www.kaz-studio.co.uk](http://www.kaz-studio.co.uk).

Clive shoots a lot of ideas with Sarah, his assistant, who is also a superb figure model. She keeps toned by aerobic kick boxing and was a competitive Latin dancer from the age of six. Sarah and Clive work well together; as soon as one of them has a new idea for a shot, they immediately begin planning and organizing, and even after working together for three years, they still maintain that professional distance when working on figure shots. Clive professes that many amateur photographers have the wrong approach with naked models—in his studio a model is only naked for a few seconds to do the actual shot—at all other times she is covered. That way Sarah, or whoever is modeling, feels completely comfortable and at ease. Shooting digitally means that they can see the image straight away, making any modifications if required. Many such ideas then go on to the website and become the subject of a tutorial session.

Future ideas include figure shots in a cathedral, although Clive has his concerns that this may be construed as blasphemous. In addition, he thinks Yosemite Park and Monument Valley would be an exciting project and he is also trying to work out how to achieve outdoor figure shots in the concrete canyons of London. As far as digital photography is concerned, Clive is a convert. "Digital is the way forward—ease-of-use and no chemical impact on the environment has to be a good thing. However, it does mean that nowadays we need to always be aware that every image has been retouched and therefore is not in its true form. This can have a huge effect when misused." But ultimately it is creativity that counts, so, as long as he can keep coming up with ideas he will be shooting models for a long time yet.

# BOB CARLOS CLARKE

"Photography is about imagination and having the skill to put a piece of imaginative thinking onto film. The equipment is about as important as a sculptor's chisel."

Bob Carlos Clarke's style of photography is so individualistic that his work is instantly recognizable. Having learned his trade at college, he set about making his living afterward by shooting editorial pictures, mostly for car, motorcycle, and men's magazines. His work from that era is filled with images of sex, violence, and consumerism, and he has been criticized for his portrayal of women as fantastic creatures rather than real people, as well as for his use of props such as guns and cars. But Carlos Clarke remains unrepentant. "My pictures are supposed to be strong. If they weren't, I wouldn't be succeeding on my own terms." He denies that the images amount to an expression of his own philosophy of life, but qualifies this by saying, "40 percent is me, but 60 percent is simply what the market wants at the time."

Currently Carlos Clarke is back in vogue, but he realizes all too well that being involved in fashion and commercial photography can result in bowing to the fickle tastes of the industry. This proved to be the case when, after a number of years of pitching sex and violence to sell products, and releasing two fetish books, he turned up in Los Angeles in the early 80s to find that political

correctness was in full swing. He was out of tune with what the mainstream wanted and his agent advised removing some of the more unsubtle shots from his portfolio. He got by with other means for a while until one of his trademark images—a woman in a skin-tight rubber dress crying on the steps of a mausoleum—was bought by a cleaning-liquid manufacturer. Sexy was back in fashion and his career took off once again.

He discovers the inspiration for his images in all sorts of places and in all sorts of things. "It may be some object that I find lying around in a junk shop whose shape attracts my visual attention," he explains. He finds it useful to wander around London, simply observing. He likes to keep in touch with visual trends, and certain influences inevitably find expression in his work. Looking back, Clarke recognizes that much of his early work had a sentimental, nostalgic quality about it despite the immediacy of the actual subject matter. But rather than becoming a trademark, it has simply served as an apprenticeship to his more recent work, which has pushed the bounds of what is acceptable in advertising. One such piece shows a woman reclining in a sports car, suggesting, "Wouldn't you like to own

them both?" Another example shows a man in a bar, with two women kissing, implying, "Drink this beer and your male fantasy will become a reality." The dressed-to-kill advertisement series caused numerous complaints, featuring carefully contrived scenes with a woman, whose beauty caused death and carnage to all men who saw her, as they became fixated on her rather than looking where they were going. The advertisement was modern, funny, and sexy.

This was a complete antithesis of his early work where he relied on chance to provide the elements in his pictures. He rarely had a clear and detailed idea of what he was trying to achieve from a particular session, but this did not matter greatly at the time for a number of reasons. Firstly, he was shooting in black and white and thus could manipulate the image during printing; secondly, most of the work was hand-tinted and so the color of the picture was entirely up to him; and thirdly, many of his early pictures were montaged. This meant that really the image was actually put together after the shooting was over.

Now, however, Carlos Clarke makes sketches before he reaches for his camera—only when he has a clear idea

*A typical Carlos Clarke shot shows a model slouched in a chair, eye make-up smudged after crying. The lighting is deceptively simple, bowing to his current ethos that the picture must tell the story, and not be overwhelmed by fancy lighting or technique.*

150mm lens, Nikon, 1/125th sec, f16









(Above) This shot started life as a single black-and-white photograph of a muddy track through the woods. Carlos Clarke then printed up two smaller sections of the negative. He hired a model and photographed her twice in the studio, producing blue-toned prints of her. Four images were then montaged onto the original print and hand-tinted with watercolors and photo dyes. The shadows around the edges of the center sections were air brushed onto the print later. 150mm lens, Nikon, 1/250th sec, f5.6

(Left) This photo is taken from Carlos Clarke's latest book, *Shooting Sex*, which chronicles his career from student to consummate professional. Bright lighting is used to capture the vivid colors of the outfit and the voracious posturing of the model. 150mm lens, Nikon, 1/125th sec, f16

of what he is trying to achieve does he actually expose film. Careful planning and concise execution have made him a sought-after photographer. He is very choosy about what he includes in the frame, saying that he always limits himself and takes out everything that does not contribute to the final image. He stresses that each element must complement the others as it only takes one small mistake to ruin the entire picture.

Although Carlos Clarke's pictures rely heavily on graphic-arts techniques, he is insistent that the techniques are merely a means to an end. He is also aware that unless he concentrates on how a certain technique will affect the final result, there is a danger that the technique itself will start to dominate the picture and will reduce the impact of the image.

The models in Carlos Clarke's pictures are simply images, rather than people. He uses them to inject a sexual element into the photograph. In the same way he might put in a car, to represent machismo, he uses his models to add a degree of sexual

danger. The unreal quality of Carlos Clarke's photographs stems essentially from his marked choice of model, prop, location, and technique. They all contribute to the pervasive atmosphere of menacing fantasy. Although Carlos Clarke uses professional models, his most recent shoot, involving nightclub advertisements, is so provocative that the professionals couldn't liberate themselves sufficiently to create the atmosphere he wanted. So he turned to friends and people he approached on the street. One girl, a dancer, had just had an argument with her boyfriend, the others had been partying until late the night before, and they combine to give the gritty, urban feel that the polished, professional models were unable to achieve.

Carlos Clarke deplores the obsession with equipment that preoccupies so many amateur photographers. "Photography," he says, "is about imagination and having the skill to put a piece of imaginative thinking on to film. The equipment is about as important as a sculptor's chisel."

His success as an advertising photographer shows that he has a strong grasp of the economics of the business, but that he is able to detach himself from much of his commissioned work. "If I identified with my advertising photography, I'd have a broken heart every day," he says.

He takes his personal work very seriously and maintains a rigidly perfectionist stance regarding its quality. He produces, at most, about 20 pictures for himself a year. Each one takes days and sometimes weeks to produce. "When I look back at those shots, I'm lucky if there are still four that I can honestly say that I am proud of," he asserts. Fortunately for fans of his work, a burgeoning website, [www.shootingsex.com](http://www.shootingsex.com), will showcase more of Bob's personal photographs, and give collectors the chance to snap up limited-edition prints.

Carlos Clarke's work manages to successfully straddle the line between reality and fantasy. Many photographers have attempted to do this and few have succeeded. One main reason for Carlos Clarke's success is that his technical skill is sufficiently broad to allow free rein to his imagination.

# LUCIEN CLERGUE

"The sea brings dynamism to my photographs. The movement of the water, the sun's reflections and shadows, the texture of the sand, play with the woman's body and transform or redefine it."

A native of the small town of Arles in France, Lucien Clergue is a fine-art photographer, author, and filmmaker. His work has been associated with some of France's most significant artists, intellectuals, and musicians, including Jean Cocteau, Pablo Picasso, Roland Barthes, and the Gypsy Kings. His fascination with photography in general, and the nude in particular, led him to set up Rencontres Internationales de la Photographie, Europe's major photography conference and showcase in Arles. It is also a place where aspiring photographers can congregate to discuss and practice their art. Clergue himself, although now in semi-retirement, runs workshops and seminars that concentrate on the purely visual aspects of the medium.

Over the decades Clergue has enjoyed worldwide success with exhibitions across North America and Europe. He received his doctorate at the University of Provence, Marseilles, under the direction of Roland Barthes in 1979. Ever busy, he has taught at such institutions as the New School of Social Research and conducted countless workshops on photographic technique, dealing with the nude in particular.

One of his last overseas workshops was in 1997 at Riverside, California, and was sponsored by UCR/California Museum of Photography. The workshop offered participants the opportunity to familiarize themselves with Clergue's work, which was simultaneously shown in a major retrospective in the museum, and to participate in an intensive workshop and critique led by Lucien himself. During the workshop Clergue experimented with digital output from film. These days Clergue still holds regular workshops, but usually in his home town.

His interest in the nude form is similar to that of a painter or sculptor. He recalls visiting the museums in Arles and measuring the figures of the sculptures there, calculating the proportions that were judged to be perfect in their day.

Through his photographs he has put into practice all he has learnt about form, and has gone further in exploring the relationship between the nude and its surroundings. His quest has taken him to locations all over the world. He rarely uses professional models because he finds they invariably add glamour and glossy sophistication to a picture. He prefers the spontaneity and lack of artifice that comes from using amateur girls as models.

The relationship between the model and the photographer is very important to Clergue. He says that there must always be respect for the model, and that the photographer should try to involve her in the picture-making process, otherwise the photographer cannot hope for any success. Clergue maintains that the natural shyness that occurs when a photographer undertakes his first nude session should not be extinguished, since it helps to bring the two participants emotionally closer.

He always shoots by daylight, finding that it complements the spirit of his photography. He thinks that artificial light, whether it is flash or tungsten, is alien to his pictures and that there is really no need for it, as a good tripod will compensate for inadequate light. Locations play a tremendously important part in Clergue's photographs. Arles itself is an ancient town, full of the remains of Roman buildings that have fired Clergue with an enthusiasm for architecture. This has found expression in his collection of pictures entitled

*This classic Clergue shot of New York in winter contrasts private vulnerability with the harshness of the urban landscape. All the interior components—warmth, nudity, plants, domestic furnishings—are designed to contrast with the cold snow and steel and concrete of the exterior.*  
17mm lens, Kodachrome 64,  
1/60th sec, f5.6



*Urban Nudes.* "Each time I photograph a nude in a room," he says, "I think very carefully about the model's relationship to the shape of the room." If a window is to be included within the frame, Clergue is careful to make sure that what is seen through it bears some relation to the foreground part of the picture.

Clergue has also produced memorable studies set in forests and deserts but, out of all locations, he loves the sea the best. "The sea brings dynamism to my photographs. The movement of the water, the sun's reflections and shadows, the texture of the sand, play with the woman's body and transform or redefine it."

Clergue maintains that the photographer cannot plan in advance what he is going to do during a session. "You must leave yourself open to what might happen. And even if you find yourself in an environment that is not everything you had hoped it would be, you must try it. This is where your imagination is really in demand."

A distinguishing feature of Clergue's pictures is his penchant for excluding the heads of his models. This started when censorship in France was much tighter; it meant that many of his friends, who posed as models for these pictures, could ensure that they would not be recognized. But there is another reason why Clergue continues to behead his models. Without a face, a woman becomes less of a character and more emphasis is thrown on to her form, and it is to this that Clergue wishes to draw the viewer's attention.

Clergue's approach to the subject of nude photography is much closer to that of a painter or sculptor than to that of the glossy studio photographer. His fascination with the female form is, as he admits, a lifelong passion.

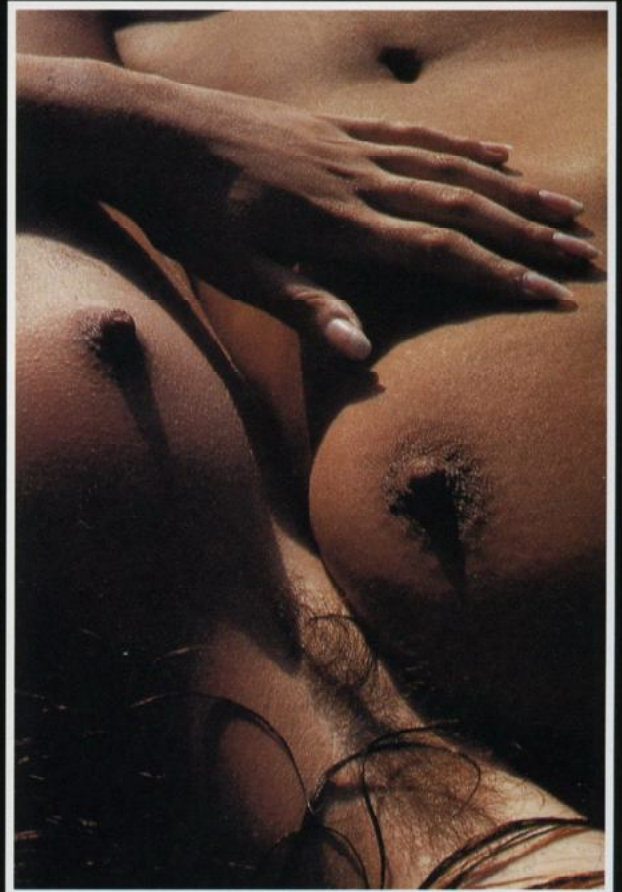

*(Above)* One of Clergue's favorite ways of portraying the nude is to reduce the image to an abstract. In this shot he has carefully arranged the models so that they produce a composition that the viewer cannot immediately make out. Each of the elements in the picture has been carefully arranged to show ordinary parts of the body in a new and visually stimulating way. 85mm lens, Ektachrome 64, 1/60th sec, f8

*(Right)* The sea has always been a great provider of inspiration to Clergue. It adds a dynamism to what would otherwise be a straightforward portrayal of the female nude. His habit of "beheading" his models allows him to represent their shapes as exercises in design rather than characters in their own right. 17mm lens, Ektachrome 64, 1/30th sec, f16

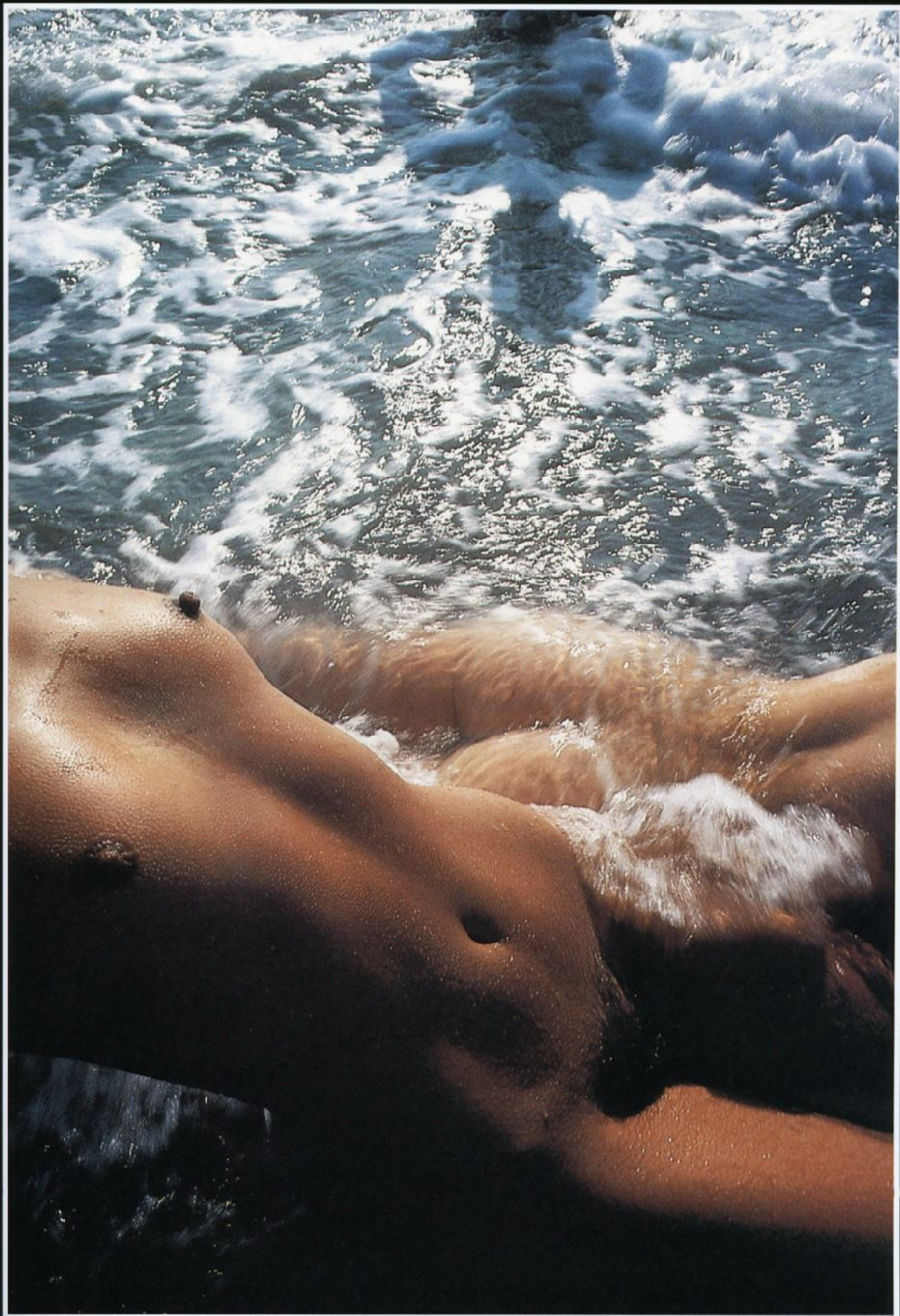

# JAN COBB

"I have a very exciting attitude to my photography. I like to have complete control over all the elements that make up my pictures. As far as possible, I leave nothing to chance."

Jan Cobb has been a photographer in New York since 1972. A graduate of the School of Visual Arts, he spent his early years specializing in shooting still-life compositions. This background gave him a clear understanding of the importance of lighting and color. He opened his first studio in 1975, where his interest in shooting women and beauty became apparent.

In 1987 Jan moved his photo studio to the heart of the flatiron district of Manhattan. This is the center of New York's photo district. Being so strategically located he was now able to see and photograph the best models that New York had to offer. Jan has since become one of the premier photographers of female bodies for skin-care companies, and his photographs grace the packages of many of their products, including Caress, Dove, Vaseline, and Pond's, to name a few.

Jan's award-winning work has been exhibited around the world and has been featured in many photographic magazines. Some of Jan's advertising clients include Princess Marcella Borghese, Fabergé, L'Oreal, American Express, Danskin, and Sony.

Cobb's cleanly executed, classically composed pictures, marked by a bold use of color, have made him one of America's best photographers of the female form. He works almost exclusively in the studio, using electronic flash for illumination. It means that he can plan exactly what he wants in advance, and can take Polaroids of the sets and the lighting before the model even arrives. When the moment comes to start shooting, he knows that the result is going to be precisely what he had in mind, whereas when he shoots in daylight, he never has that

kind of control. He will in fact only shoot in daylight if he is trying to create some particularly exotic effect, such as a sunset, that would be very hard to create in the studio.

There is no hidden agenda or subliminal message in Cobb's photos. He makes it clear he is not trying to make any statements. "I am just photographing what I consider to be a particularly attractive form—I don't want my models to come across as characters," he says. "The women I photograph are beautiful, and I am simply trying to bring out that beauty to a wider public. I put women on a pedestal, because I think their appeal is worthy of that treatment."

He is very choosy about models, preferring professional girls to amateurs. A model's proportions are very important to his work, and he does not find it easy to discover a girl with exactly the right shape. Skin quality is another aspect to which he pays particular attention, as he frequently lights the model from an oblique angle, and any blemishes show up badly.

Cobb maintains that he did not realize that he had a particular style until he saw several of his pictures in a magazine portfolio. He then noticed that all the shots were horizontal, and either had a strong shape on the left side and a weak one on the right, or vice versa. But he denies that he developed a style consciously.

He uses 35mm cameras for his work because he prefers the rectangular format. His favorite lenses are the 85mm and 105mm optics.

Along with many other photographers, Jan became fascinated with digitally enhancing and manipulating images. "The computer enables you to take an

*The helplessness of the blindfolded woman creates a sense of mystery to this photograph. The sensual curves of the woman's body are brought out by the stark lines of the minimalist background. The lone figure creates a powerful statement.*  
85mm lens, Kodak T-MAX 100,  
1/125th sec, f16

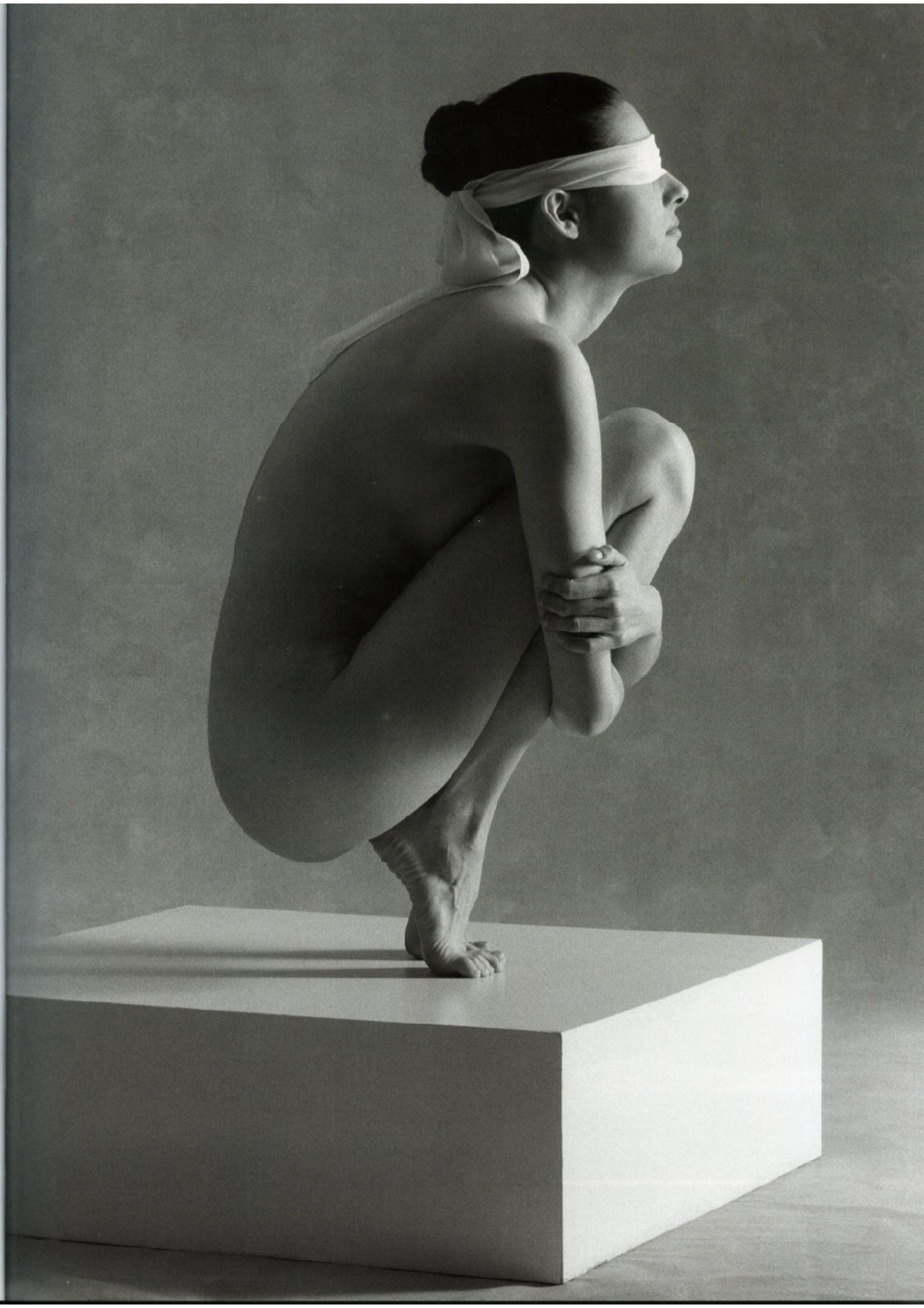





*(Left) This photograph was an experiment to create the colorful flag within the monochromatic photo. The black-and-white negative was scanned and the cloth was then manipulated in Photoshop to create the French flag colors.*

*120mm lens, Kodak PLUS-X Pan Pro 100 ASA, 1/125th sec, f16*

*(Right) The sensuality of this woman's movements are enhanced by the afternoon sun coming through the opposite windows. This photograph was created in the studio with electronic flash units and warm gels covering the strobe heads.*

*140mm lens, EPR 120, 1/125th sec, f11*

*(Below) Jan often photographs the female torso. The draped cloth here creates a certain elegance.*

*105mm macro lens, Kodak TRI-X 400 ASA, 1/125th sec, f16*





existing beautiful photograph of a woman or body and raise it to a level of tremendous grace and elegance. You can composite photographs of women to create a story or illustrate a concept of beauty.”

After practicing his craft for more than 25 years, he continues to explore the art of creating truly great photographs. Jan’s bold use of color, his uninhibited graphic compositions, and his knowledge of the female form are some of the things that make his photographs really stand out from the rest. He is still waiting, however, for that elusive book company to come along and publish his extensive collection of nude and erotic work.

In order to catalog, archive, and make available his vast wealth of photographs, Jan has created Gothamstock, an online photo agency. Here you can find many of Jan’s images and also the images of some of the finest photographers in the world. Jan will be developing and adding to this collection for many years to come. Visit [www.gothamstock.com](http://www.gothamstock.com) and type Jan Cobb in the search box to view Jan’s extensive library of photographs.

His affinity for form and color led him to conceive and complete a two-year project photographing fresh produce. The collection and subsequent stock agency handling these photographs is also one of Jan’s creations: [www.gothamstudio.com](http://www.gothamstudio.com).

Cobb’s work demonstrates how the techniques of the still-life photographer can be successfully applied to glamour photography. The final product is a beautifully-crafted image that relies on natural beauty for its appeal.

# EMMA DELVES-BROUGHTON

"I'm always working on my own projects. I see it as a way to improve myself, meet new models, have fun, and work without having the pressure and deadlines."

One of the hottest new photographers in the glamour, lingerie, and fetish markets, Emma Delves-Broughton is one of very few female photographers in what has predominantly been a man's world. She is currently negotiating a big-money book deal and knows just how to make a woman look sensational. Emma turned professional just two years ago, but first exhibited her work in the early 90s. While these days it's the stunning and vivid color work that she is better known for, her first love was for black-and-white and hand-tinted photographs.

The road to success started with a degree in graphic design in 1989, after which she joined a company called Colour Studios in Bath [UK], doing exhibition graphics, printing photos, and, much later on, the in-house photography. While designing graphics gave her commercial grounding and an appreciation of color and design, it was photography that was her passion. Emma recalls, "My enthusiasm grew for photography, and I did all of my personal work in my own time. My love for black-and-white photography grew, as did my skills for toning and hand tinting. I didn't really get enthusiastic about color photography until about three years ago. I now love it just as much. Black and white tends to be for my own personal projects now as, commercially, it isn't as popular."

This didn't seem the likely direction for her career, even though she had her first joint exhibition in 1991. "My first joint exhibition "Reshape," along with two of my work colleagues, was near Bath. I sold quite a lot of pictures, which was great. Later that same year I exhibited work in another joint exhibition called 'Bath Women Photographers' at F.Stop."

However, it wasn't until 1998 that Emma had her first exhibition in her own right called "Lipstick and Lashes," shown at F.Stop in Bath. This proved to be the catalyst that brought her commercial recognition and success. Emma explains, "The same show was taken to London at the Skin Two Rubber Ball. At that point I was starting to get work published and thought it would be a good time to leave my job and be a freelance photographer. I didn't actually do this for another two years, but by that time I was working part time and doing as much photography as I could in my own time, building up my portfolio and my skills."

This led to her first commercial shoot in 1999 for lingerie company, Pigalle. A second commission for Pigalle became hot property when the company was bought out by Agent Provocateur. It led to book covers for Virgin and Carlton Books, two catalogs for *Glamour Girl*, and contributions to *Masterpieces of Erotic Photography* and *Erotic Fantasy Photography*. Then there was the magazine work and exposure in *Skin Two*, *Marquis*, and men's magazines such as *GQ* and *Front*.

She doesn't have a studio of her own, since most of her commissions are on location, but will rent somewhere when necessary. Mamiya is her favorite brand and when on a shoot she can be seen armed with a RB67 Pro, 645 Pro TL, C330, and a Canon EOS 3. She doesn't use digital, but is happy to scan pictures into the computer for minor tweaks. Her basic requirement is for equipment that she can get into the back of her car.

In fact, Emma is less than complimentary about the effect that digital is having on the profession. "As digital photography has become more

and more popular, I think that people are more keen to have a go themselves, and are less inclined to want to use a professional photographer. This is certainly true for a lot of pictures of clothing on websites. I'm not convinced that photography is a profession that is valued, as people don't understand why they can't use photographs for no fee. If you won't do it for nothing, then they think they can find someone that will, and they do. All of these factors don't help when photography is your living."

Although known for her color work, Emma herself is skeptical that it can be readily identifiable as such, but admits, "People tell me that they can tell if I've shot something, though it's not something that I've really thought about." Her influences and favorite photographers though, comprise an interesting list. "I love looking at Helmut

*Emma's work is split between commercial assignments and personal projects. This photo, shot at a castle in Wales, features handmade foundation wear for the Glamour Girl catalog. While it looks natural, thanks to the light coming through the window, it is actually balanced with a large umbrella and portable flash. 180mm lens, Fuji Provia 100, 1/30th sec, f5.6*





*(Above) An interior personal project shot, featuring a dress by Pigalle. As the dress is glossy rubber, flash heads were used both to light the model and to create the shiny reflections on the dress. 90mm lens, Fuji NPS 160, 1/30th sec, f11*

*(Right) This was shot as part of a series for Glamour Girl catalogue. The lighting was fairly sophisticated with a twin flash head and softbox combination providing flattering and even lighting, as well as a flash head with an umbrella offering fill-in flash. 180mm lens, Fuji Provia 100, 1/125th sec, f11*

Newton, Bill Brandt, André Kertész, Madam Yvonde, Julia Margeret Cameron, Norman Parkinson, and Man Ray. I enjoy looking at lots of types of photography, and used to go to galleries a lot, although I don't get much of a chance to go now. Bath has lost two of its main galleries, the RPS and F.Stop, which is a great shame."

Though increasingly busy, she still has time for her own photographic interests. She remarks, "I'm always working on my own projects. A lot of the work on my website is personal projects. I see it as a way to improve myself, meet new models, have fun, and work without having the pressure and deadlines."

Does this mean she continues to use herself as a model in her photos, as she did in her early days? "I still do that and I enjoy it. In fact, most requests that I get from people who want to buy my photographs are for the self-portraits. I've never really thought of myself as a model so I find it quite flattering really." Being a woman in a predominantly male world has other advantages too. "Being a woman, and photographing women, is great, as we already have an understanding—I know how to make them look good and they can feel comfortable with me. There are no hidden agendas. Some of my models have the odd incident where the male photographer can make them feel really uncomfortable, which isn't a great situation to be in, and gives those, who do what I do, a bad name."

Currently Emma is negotiating with a book publisher to have a collection of her work published and aims to travel more and photograph people while on the road. She has recently been to Los Angeles and spent her time snapping new faces. In amongst the commercial assignments Emma is also working on a series of catsuit images—"Katwoman" being one of her early and most successful photos. She explains, "I'm using a mixture of models with their own outfits, plus some catsuits from various latex designers." So whether it's for her own designs or for commercial application, you can be sure of seeing plenty more of Emma Delves-Broughton and her sassy and stunning photography in the future.

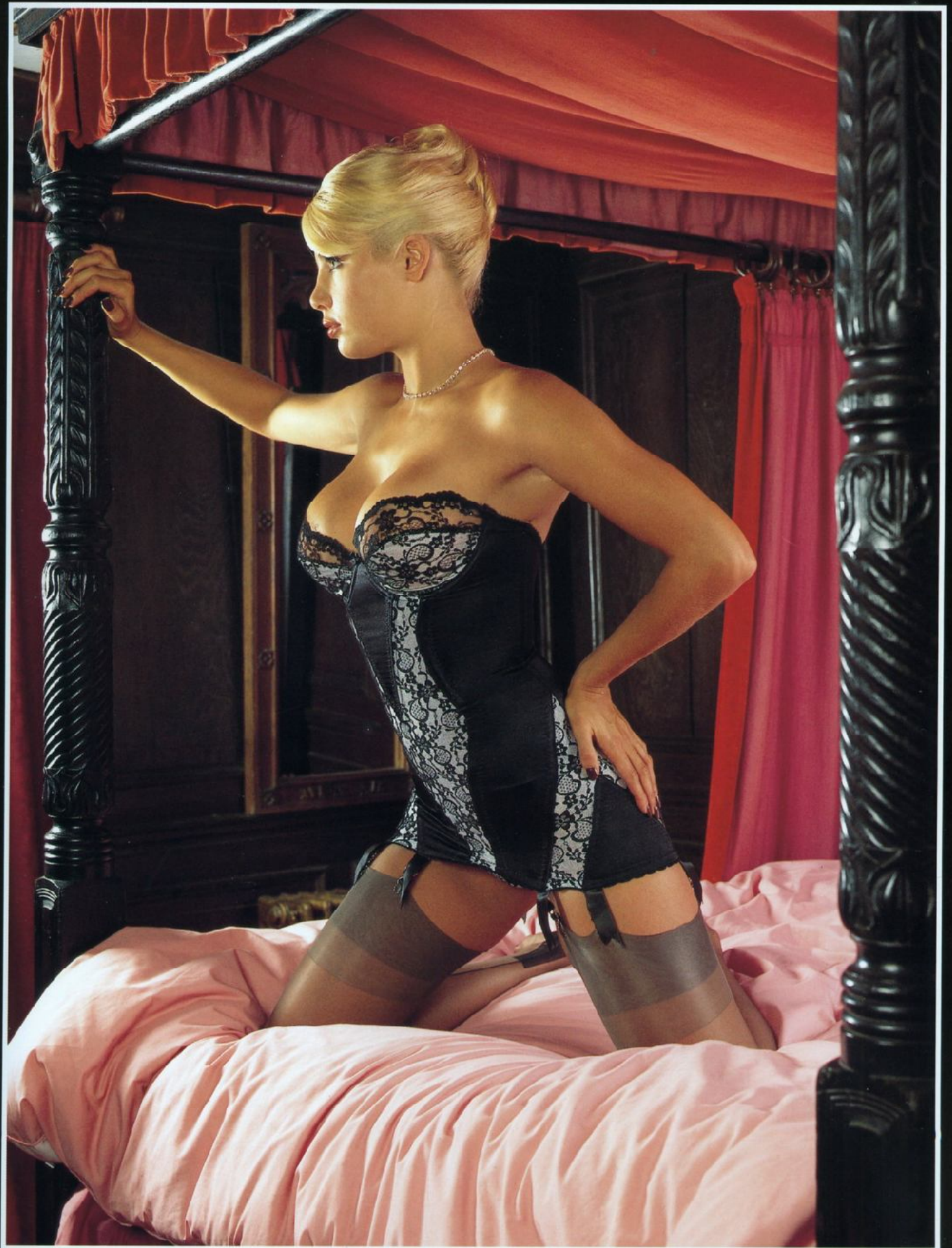



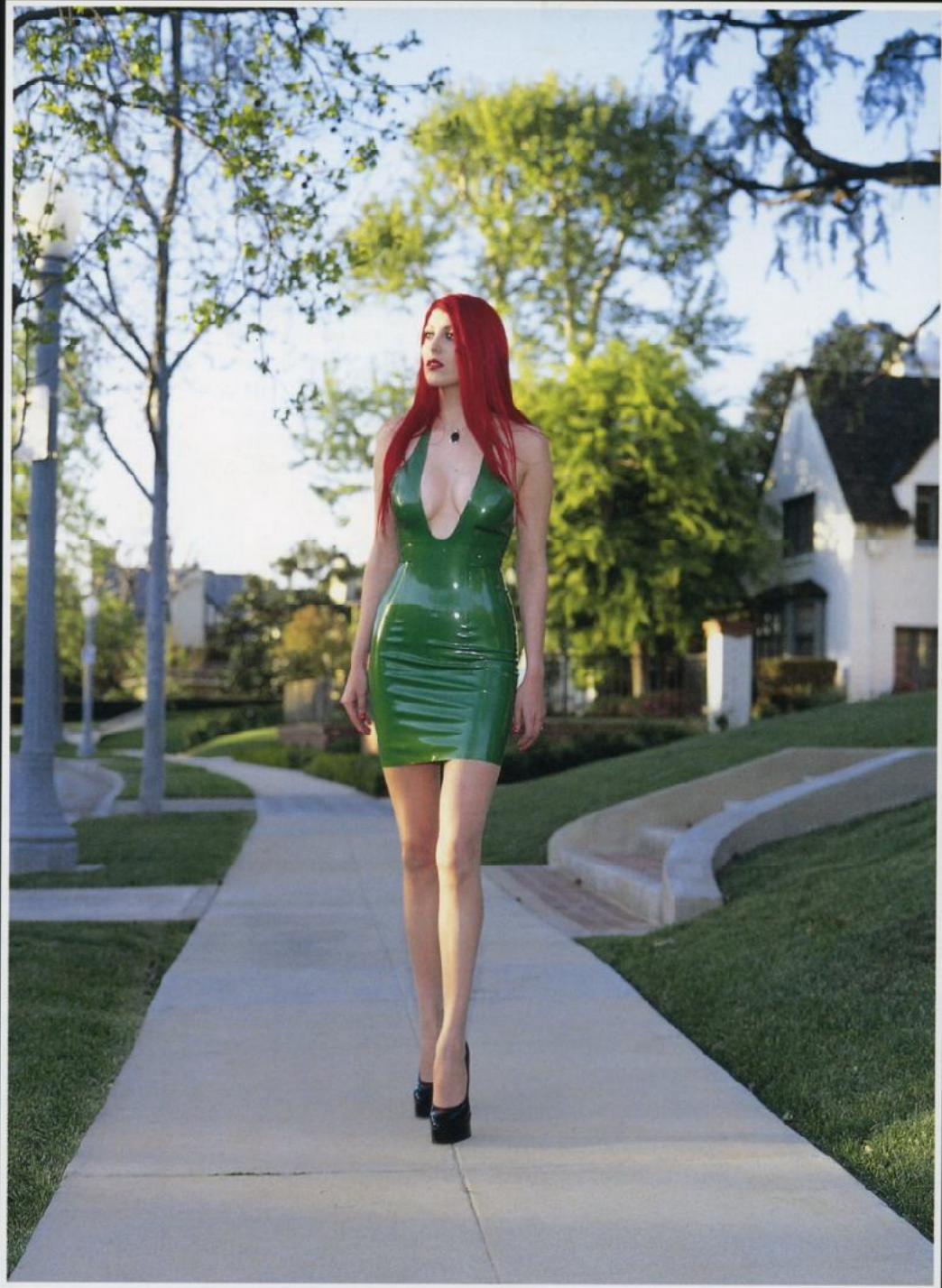

*(Left) This shot is all about color and for once does not feature an elaborate background. A flash head was used to generate the graduated effect in the background, while the perfectly made-up model was lit with flash heads from the front to create sparkle and reflections.*

180mm lens, Fuji Provia 100, 1/125th sec, f11

*(Above) This is one of Emma's personal shots that she took while she was on vacation in Los Angeles. While the model appears to be sauntering down a typically suburban sidewalk, she is in fact perfectly posed and lit by natural light, and also fill-in flash to bring out the shiny aspect of the PVC dress.*

80mm lens, Fuji Provia 100, 1/60th sec, f8



# ROBERT FARBER

"With a nude, what I would look to do is to isolate certain parts of the body to bring attention to the sensual curve of the model or some type of body language that would also incorporate dramatic lighting."

After selling over half-a-million books, publishing around 60 posters, being crowned the PMA Photographer of the Year, and conducting major campaigns for fashion and beauty magazines, you'd think Robert Farber would have tired of it all. Instead, he created [www.photoworkshop.com](http://www.photoworkshop.com), a massive photography-teaching internet portal that receives a staggering two million hits a day, as well as having released a hardback book of high-quality artistic nudes called *Farber Nudes*.

It should come as little surprise to those familiar with Farber's work that originally his interest was not photography, but painting. The ethereal and haunting quality of much of Farber's nude output owes much to his understanding and appreciation of light. Farber comments, "When I first went to the University of Miami I didn't have an interest in photography. My interest was in painting, but my parents didn't want me to go to college to be an artist so I majored in marketing and business. After I left college I started experimenting with photography, but produced them with a painterly style. I showed them in outdoor art shows. I had always wanted to paint but I didn't have the ability to do it the way I wanted to. So I picked up the camera instead.

"It was through these art shows that I started to gain commercial success. At one show, someone saw an interior that looked like a painting and asked if I could put a model in one of them. He was an art director with the Cotton Inc. account. Suddenly I was a fashion photographer. I didn't know anything about it; from getting a hairstylist, or makeup artist, or even what to charge."

So Farber didn't take the long route of being a photographer's assistant?

"I never assisted because my interest was in the artistic side of photography, not the commercial. My first book came out in 1976 through a PR person that I also met at an outdoor art show. One of her clients was a large book publisher and they liked my work. That became a book called *Images of Women*."

It was at this point that his career started to take off, with work for lots of magazines like *GQ*, *Playboy*, and *Viva*. Farber has fond memories of that particular title: "Viva was a great outlet, it was like a European fashion magazine here in the United States with stories that included nudity with good photographers and good models. It was a great showcase."

He even started getting work from *Penthouse* whilst using pseudonyms to keep his own name and reputation associated with his fine-art nudes. One of the publishers wanted to do a technical book on fashion but Robert disagreed with the content saying, "Let's not do that, let's do a book that tells people about the ins and outs of fashion photography. How to put a shoot together. Who does and gets paid what."

The publisher agreed and the book was published, attracting those who wanted to know more about glamour and fashion photography; *Professional Fashion Photography* sold around 125,000 copies.

With his reputation for fine-art books you might think that Farber wields hugely expensive, large-format cameras around in a hi-tech studio. He doesn't. And his equipment list is modest by most standards. A 35mm Canon, the Contax 645 for medium format, Elinchrome flash, and an Imacon scanner are all employed to maximum

effect. He's also been experimenting with an 8mm Minox and is happy to scan his images for minor tweaks. A recent show consisted of entirely digital prints but he denies being a digital convert, maintaining that he is simply experimenting for now.

When asked about who his influences are, Farber comments, "Mostly painters because of my background; the Dutch school because of their use of directional light; and the Impressionist painters, with their soft pastel colors. Actual photographers would be Henri Latriques, Stiechen, and Hurrell."

A trademark Farber image can be described as one that reflects his mood and his feelings at that time. What he looks for in a landscape image, especially when photographing a still-life, is a composition that exists only through his own point of view. Because the photograph needs to be composed, to be separated from its surroundings in order to create a graphically pleasing image, another person could pass the same subject by without being aware of it. That's typically what he looks for in a still life or a landscape. When it comes to photographing a nude, it's slightly

*Using handheld cameras and natural light, this image is all about texture and diffusion. The model is in a classic pose with cascading fabric revealing her nudity underneath, but her face is hidden to maximize the mystery.*  
28-135mm lens, 1000 ASA rated at 800, 1/250th sec, f16

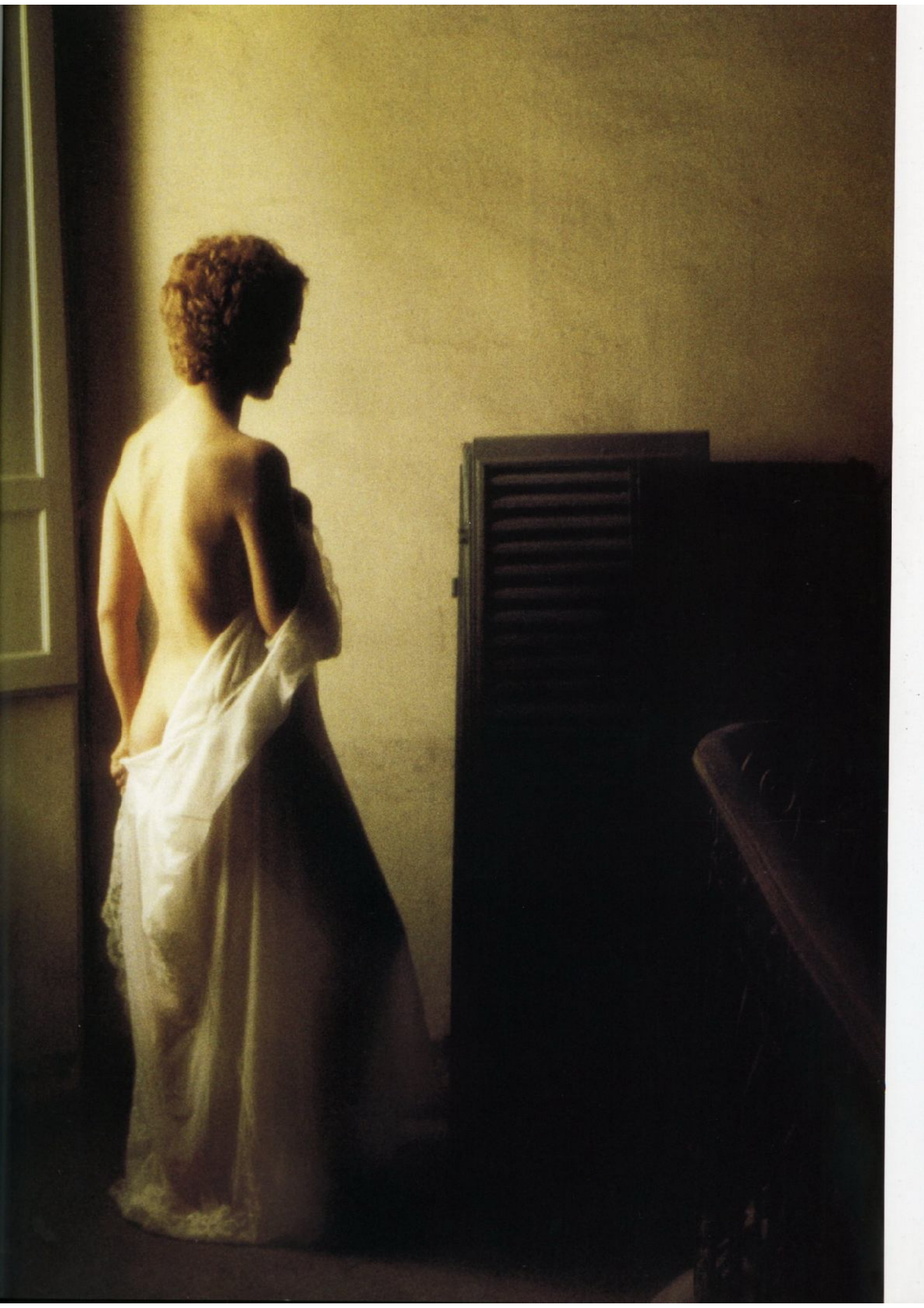

*(Right) A more extreme example of hiding the face is to crop off the head entirely, and this view through an old window is very reminiscent of Lucien Clergue's work. The window also acts as a frame and a metaphor, allowing the viewer to see the essence of the model, without ever revealing the identity.*

70-300mm lens, Agfachrome  
1000 ASA, 1/250th sec, f8

*(Far right above) Lightness and shading are predominant here. The model has turned away from the camera and by overexposing the shot, the flooding natural light turns the scene into something impersonal and ethereal.*

28-135mm lens, 400 ASA  
Agfapan, 1/125th sec, f8

*(Far right below) The effect of this shot is almost voyeuristic. The subject is partially covered, as if coming out of a bath. Her foot movements echo this, as though there is water just around the corner, yet the shot is from above and outside the scene, letting the viewer see a glimpse of the scenario while retaining the privacy.*

Contax 645 lens, 200 ASA  
chrome, 1/125th sec, f16

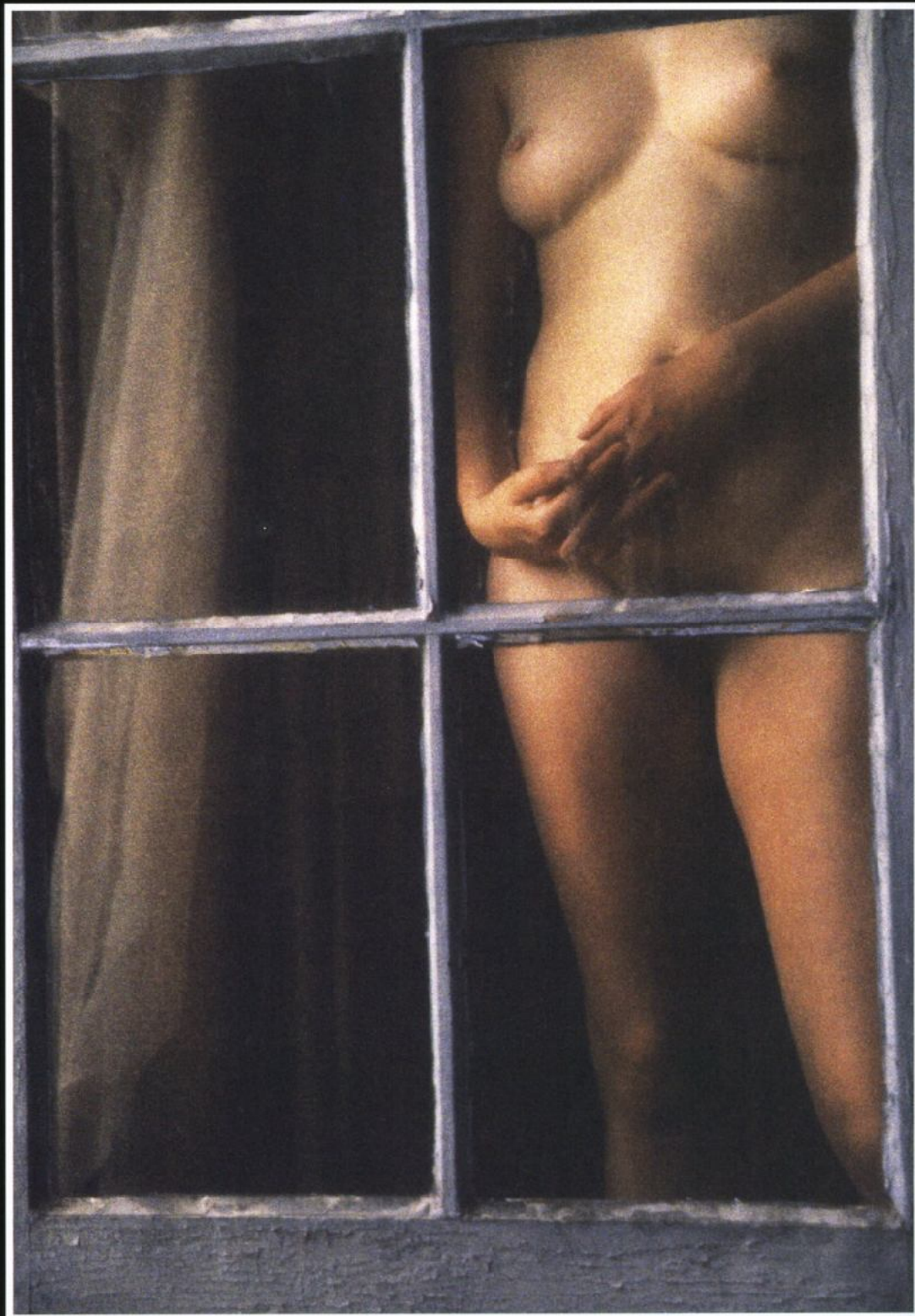



different, as Robert explains, "There are subtleties in sensuality that apply in the same way. So with a nude, what I would look to do is to isolate certain parts of the body to bring attention to the sensual curve of the model or some type of body language that would also incorporate dramatic lighting."

His photographs have a reputation for a soft, surreal flair. Many of those images are not visually soft but are soft in mood. This doesn't have to be technical or be a photographic process. Farber elucidates, "It's part of a style and can be the mood of a model, the surroundings, the feeling, the quietness of the image. My idea about soft focus is that there's something that looks good about it but you don't know exactly what it is. If you deliberately shoot something with a soft-focus filter it ends up looking like a get-well card."



This approach permeates through to Farber's nude work, which works well because it has been naturally shot and not set up. The shot has been taken impulsively when everything looks to be right. Farber likes the nude because he finds it challenging. He declares that when looking at pictures of nudes you can get the sense that it's all been done before. But when Farber shoots this particular subject he doesn't think of it like that, he concentrates on making the photograph look pleasing. His pictures are made impulsively, based on where the model or the light is. He tries to give the image more mystery by concentrating on the form, not the face, which he finds to be an invasion of privacy. Farber declares, "When you have some talent and if you're lucky and in the right place at the right time, the model doesn't need to have a great body but it has to work well with what you're doing." Farber doesn't cast his models in the same way that commercial shoots do for a fragrance or soap advertisement. For these, the skin or the legs have to be perfect. He wants to get as far away from commercial work as possible, and to keep on creating those ethereal and hauntingly beautiful nudes that have made his name what it has become today.

# NIGEL HOLMES

“The interesting jobs are the ones where they give you a free reign within the brief. After all, they are paying you to be creative so they should always let you create.”

All the leading glamour magazines, instructional videos, and web-based tutorials have carried the Nigel Holmes name. He is a photographer who has quietly gone about producing a lifetime's output of top-quality glamour photography and his work has graced everything from the tabloid press, to the best of the top-shelf men's titles, to jigsaw puzzles. Nothing seemed further from that goal when Nigel completed a qualification in painting and decorating. That gave way to a career in graphics and print design but the photography side took off when he landed a weekend job with one of the UK's then top social photographers, Gilbert Cox. It started as carrying bags for the portrait and wedding photographer and gradually turned into a full-time job. Cox taught Holmes that good photography had nothing to do with cameras—a camera is just a tool—but that the important thing is what you put in front of it. Nigel numbered and mounted prints, made the tea, and was let out to do weddings when the boss had another job on.

After spending three years with Cox, he went freelance in 1979 and refused to have anything to do with weddings ever again. Nigel comments, “I hated them. Even now I get the creeps if I walk past a church where some poor snapper is attempting to get a stunning picture of an over-large lady in full war paint and a huge Cinderella dress.” Since going freelance in 1979 he has specialized entirely in glamour photography.

Originally he used his lounge as a studio, moving all the furniture to one end then setting up the lights and background at the other. During that time he sold hundreds of pictures to leading magazines plus the tabloid newspapers and no one suspected that they were coming from a temporary

studio that had to be dismantled after every session. One of his very first successes from the ad hoc studio was when entering a competition run by *Men Only* magazine. The brief was to submit 20 glamour photos for possible publication. The competition was run simultaneously in both UK and US publications, and Nigel won both, a feat that has never been equaled.

One house move later and two bedrooms were converted into a full-size studio that could be used without causing chaos in the rest of the house. As more commercial work for the men's titles came in, his need for studio space increased and this necessitated a move to a large industrial unit on a modern factory estate. The studio was created out of an empty unit, much to the constant distraction of the other occupants of the estate. A stream of pretty girls were constantly walking past their doors, leaving Nigel to wonder how much work actually got done by his neighbors. The studio was a drive-in to enable all manner of vehicles to be used and photographed with attractive girls draped over them. There was a 30-foot-wide infinity curve for seamless backgrounds, and a full array of lighting gear. Shooting with two Bronicas for medium format and two Minolta 35mm bodies for faster work, Nigel had full creative freedom to continue his constant creative glamour output.

Very much his own man, he isn't influenced by any one photographer but rather absorbs the best styles of those he likes the most. By being flexible and not being tied to one particular style he ensures that the work keeps flowing, though admits that subtle use of lighting is a key technique. “Lighting plays a bit part in what I do and many of my better shots have been taken with a minimum amount of light or certainly

under close control. I am not into great floods of light and try to keep the light concentrated in the right areas.”

The briefs for commissioned work can be a sore point. Nigel comments, “What I like is a relatively open brief, something where I can use my own brain. There is nothing worse than an art director who gives you the total idea and then stands over you, sometimes asking to look through the camera. You just become a button pusher. The interesting jobs are the ones where they give you a free reign within the brief. After all, they are paying you to be creative so they should always let you create. Many don't understand that.”

Nigel has photographed many of the world's top models over the years but maintains that, while they make life easier, there is still something to be said

*This shot was set up to imitate natural light coming in through a window. But, in fact, the window doesn't actually exist—it is just a hole in a panel of wood with a net curtain draped over it. The main light has been directed through the false window, and the netting has softened it. The only other light used is a widely diffused one at the camera position to act as a fill-in.*

180mm lens, Fuji RDP 120,  
1/32nd sec, f11





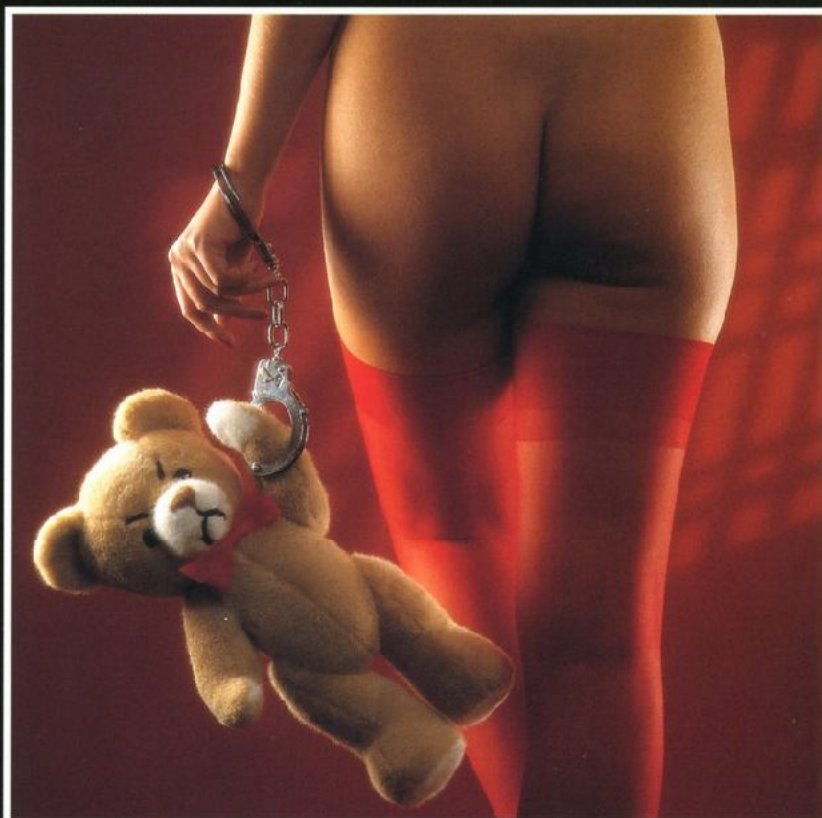

*(Above) Much of the lighting for this shot came from the back, with several black panels placed strategically to keep the lights from shining into the camera lens. The background was simply a roll of red paper with a projector creating the light pattern.*  
150mm lens, Fuji RDP 120, 1/32nd sec, f16

*(Left) A lot of space is needed for a shot like this one. The studio flash lights will stop the movement for you, but you do have to choose the exact moment to press the trigger when the action is at its height. The lighting has been controlled so that the model remains the most prominent point of focus in the picture and is lit from three different sources; the model is lit by a studio light directly in front of her and which has been fitted with a snoot; a second snoot has been set low on the floor and fires upward at the fabric that billows out behind her; the third light is an effects light that is throwing a light pattern onto the background.*  
80mm lens, Fuji RDP 120, 1/32nd sec, f16





about that fresh new face. He shoots as much personal work as he can but still within the bounds of making a living. Nigel likes his new cars and holidays too much to adopt the life of the starving artist in his garret.

Eventually trends in men's magazine photography veered away from the studio and toward more location work, so Nigel sold his studio to concentrate on location work, hiring a studio when required. Today he has sold all his film equipment and has gone completely digital with a Bowens lighting setup that is used in a more modest studio appended to his home. It keeps overheads manageable but is large enough to concentrate on the type of jobs he likes doing.

A long-running video series teaching glamour photography reached 19 editions before Nigel decided that the future for this kind of product was on the internet and it is this project that now occupies much of his time. Pictures from all his new sessions end up at [www.girlfiles.co.uk](http://www.girlfiles.co.uk). The site is designed to help glamour photographers learn about lighting and the tricks of the glamour trade that Nigel has painstakingly acquired over the years. For anyone starting out and hoping to make a living from glamour photography, this is surely one of the best resources available to learn from the man who has spent the last 20 years doing just that.

*(Left) It is possible to create some stunning effects with the use of only one light. This photograph was shot using one light with an umbrella positioned slightly to one side of the model, giving a warm, sensual glow to the entire picture.*

150mm lens, Fuji RDP 120, 1/32nd sec, f11

*(Right) This photograph has been shot using two different light sources to give the impression that it was taken using natural light. The first light—the window shape—has been projected by using a spotlight fitted with a cardboard cutout of a window. The model's face, however, has been lit with a separate light—a studio light that has been reflected back via a magnifying bathroom mirror, creating an interesting effect.*

140mm lens, Fuji RDP 120, 1/32nd sec, f16



## CHAS RAY KRIDER

"Through my use of composition, lighting, and an uncanny placement of subjects, I hope my work has a unique perspective."

When a man counts David Lynch and Helmut Newton as two of his favorite artists, you know that his photography is going to head into interesting, surreal, and heavily stylized territory. Chas Ray Krider describes his own work as having psychological and sexual tension. "Through my use of composition, lighting, and an uncanny placement of subjects, I hope my work has a unique perspective."

While having recently been featured in everything from *PURE*, *Erotica*, Dutch and German *Penthouse*, and *Amateur Photographer* magazines to a book list that includes *Love*, *Lust and Desire*, *Femme*, *Biondes*, *The Mammoth Book of Erotica*, and even *Lighting for Glamour* and *Still Life*, what currently occupies Krider's time is his six-year project, *Motel Fetish*. This came to fruition in October 2002 when Taschen GmbH published a book of the project and unleashed the imagery that crosses numerous boundaries of art, fashion, fetishism, surrealism, sexual tension, and the stylishly erotic.

It's been a long time coming for Krider, who gained a Bachelor's degree in sociology and subsequently taught himself art and photography. Chas recalls, "After college I picked up a Lieca and began as a street photographer. In the beginning I worked at any job that would give training and access to equipment and technical facilities, ranging from darkroom technician to photographer's assistant. I am basically an art guy. In the part of the US where I live, there are very few clients that can use my vision. Photography is my marketable skill, so when the phone does ring, I will consider most job offers, no matter how mundane, although I draw the line at weddings. But I do exhibit in galleries and sell fine-art prints."

However, the determination to fund his own private vision is what has driven Krider on. He prefers to forget the dull jobs. There were "too many to list, and all best forgotten. I take the money and spend it producing my own personal vision."

Fortunately, as his commercial reputation increased, the work knocking on his door became more interesting and better suited to his stylized vision. "The latex fashion designers, House of Harlot in London, had me shoot part of their collection in my *Motel Fetish* style. They shipped in 15 outfits. I photographed half here in Columbus with my favorite local model and then flew to LA to shoot international fetish model, Dita Von Tease, in the remaining ensembles. House of Harlot gave me complete freedom, which is rare in the commercial arena.

"My studio is an old storefront. I primarily shoot with a Hasselblad. The 6 x 6cm format is ideal for my work. The Hasselblad's format gives my images a greater sense of the space in which my models appear. The lenses I consistently use are 60mm, 80mm, and 100mm. I shoot color negative for my personal work; Kodak VC160 and 100T. My lab gives me 5 x 5 in proofs, which I then scan on an Epson 2450. My portfolio is comprised entirely of digital prints—I have experimented with 4Mp and 5Mp digital cameras. I like the potential of what I have seen with digital."

With *Motel Fetish* now at the conclusion, as an initial project, where does Chas go next? "I've written a film treatment for *Motel Fetish* because I think there is a very interesting story within the *Motel* that would make a great film. I have produced a digital video sketch of the emotion and pacing

of what the film could be and I am currently producing a CD soundtrack to complement the *Motel Fetish* book—music to listen to while you look at the images. This soundtrack could work into my film concept. The CD will be available on my website, [www.motelfetish.com](http://www.motelfetish.com). I have enough images for a second *Motel* book, although I would like to broaden out to a second book to include additional types of imagery, such as the work I do in the digital realm."

Whether he does get to collaborate with David Lynch—and his similar style of sexual tension amid suburban dysfunction served up with surreal and startling imagery would seem ideal—you can rest assured that you'll be seeing plenty more of Chas Ray Krider's visceral photographic vision.

*The low lighting levels and long exposure times lead Krider to describe shots like this as being on the "edge of disaster."*  
80mm lens, Kodak VC 160, 1/2 sec, f5.6





*(Left) Although the models start off fully clothed, part of the Motel Fetish attraction is seeing how far they will go after a few shots in their underwear. Krider is looking for dangerous attraction. 60mm lens, Kodak VC 160, 1/4th sec, f8*

*(Right) Table lamps feature heavily in many shots, lending the scene a seedy color cast. However, out-of-shot reflectors and fill-in flash are used to complement the lamp lighting where it falls short.*

*100mm lens, Kodak 100T, 1/8th sec, f5.6*

*(Below left ) Krider has a large collection of vintage underwear, in which he dresses the models with utmost precision. If a suspender or seam is out of line, then the picture has to be reshot.*

*80mm lens, Kodak VC 160, 1/8th sec, f5.6*

*(Below) Although shots like this look haphazard, they are purposefully set up, with the Hasselblad camera tilted on the tripod and the light sources arranged to produce specific areas of light and shade.*

*100mm lens, Kodak 100T, 1/8th sec, f5.6*

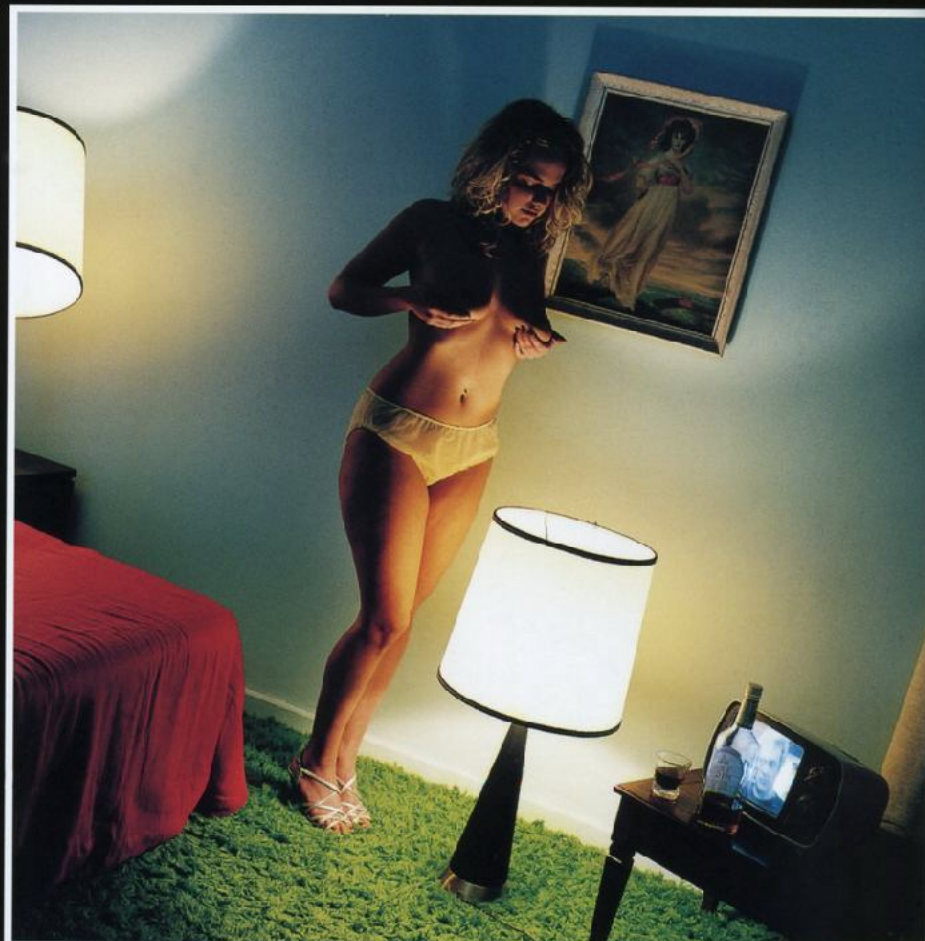
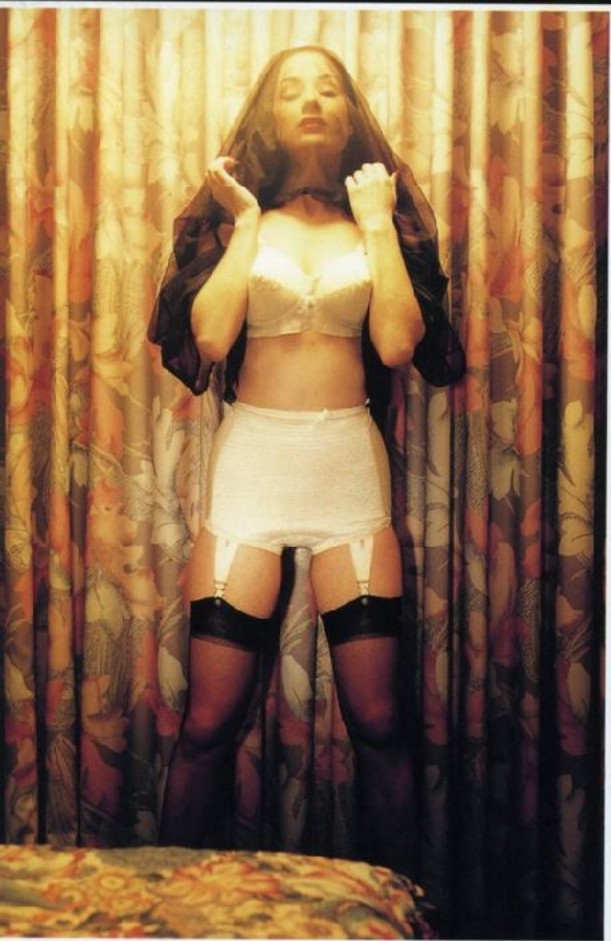

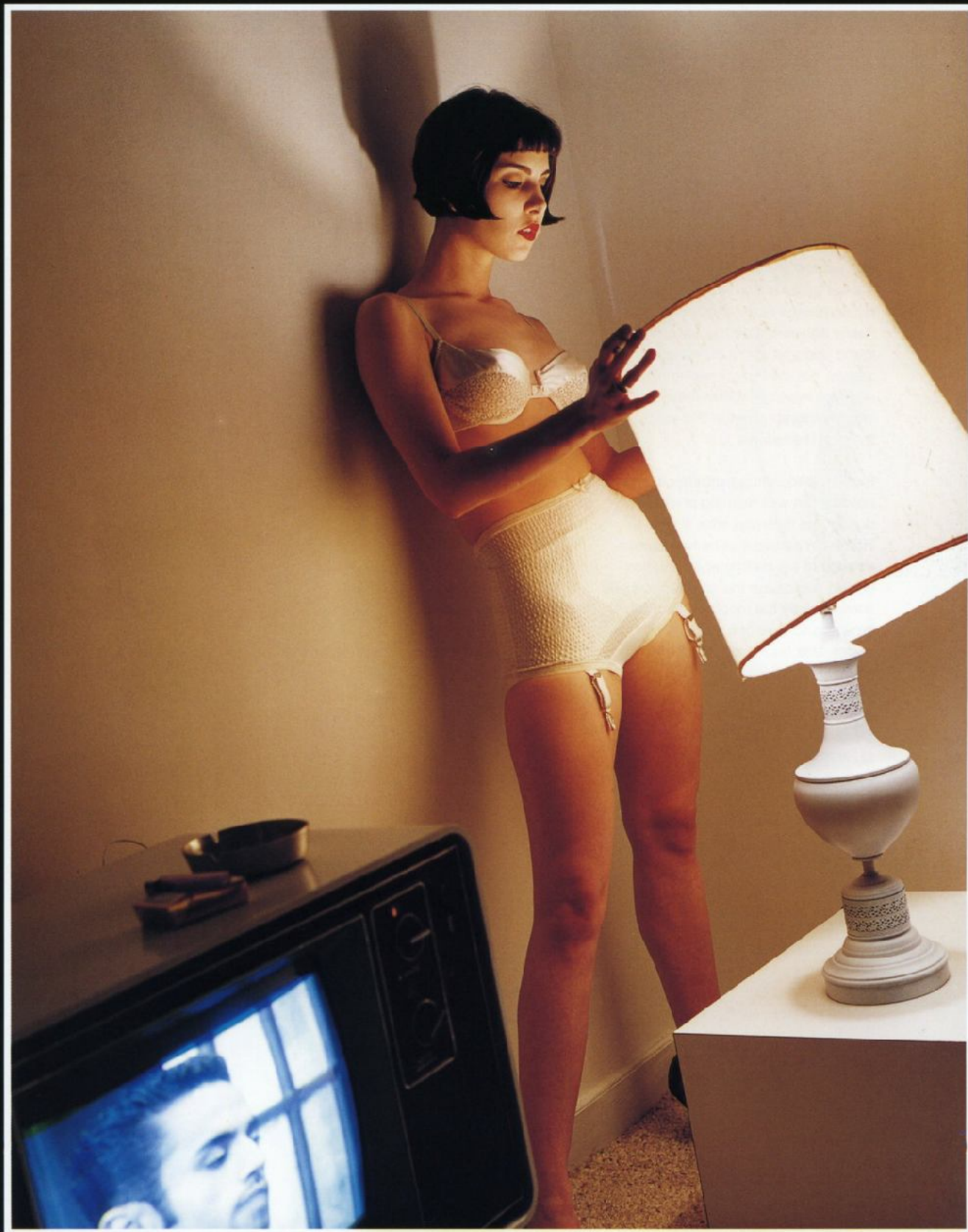

## ERIC KROLL

"It is a cliché but I get the most satisfaction from doing my own work. I know when I have taken a good photograph and in particular I like taking photographs that hinge on the surreal."

One of the busiest proponents of fetish and surreal glamour books on the market today is Eric Kroll. Despite taking photos of the female form for nearly 30 years, Eric has never tired of it and declares that it is neither the money, nor the buzz of seeing his name and pictures in print that enticed him into photography in the first place, but the girls themselves.

Kroll studied cultural anthropology at college, but was learning photography during that time and after. It was an interest in people that he has carried through to his photography and has helped him create the right rapport and subsequently the mood of the photos he wants to take of a model. Eric admits that his initial enthusiasm for glamour photography was because, "I wanted to be close to naked girls so I learned the craft. In college there were plenty of more experienced photographers, so I'd ask questions. When I worked as a freelance photo journalist in New York from 1971 to 1990 I took every job going and if it was something I didn't know I'd ask another photographer. In the early years I did some minimal assisting—for one job I assisted an architectural photographer—but this was more to make money than to gain knowledge."

Having got started, his very first job was memorable for the simple reason that it paid for his suit to be cleaned. Eric explains, "In June 1969 I had just graduated from the University of Colorado in cultural anthropology. I moved to Taos, New Mexico, and had no idea what I was going to do. I was coming back from Five Spot, a commune at a local hot spring, and I saw a woman wandering through the desert and I thought it was Georgia O'Keefe. I grabbed my 35mm telephoto and snuck up on her. She caught me

before I got a shot off and asked me what I thought I was doing. I told her I was going to take her photo. She would not let me do this, but invited me into her studio the following Monday to photograph her watercolors. She was a wonderful woman named Leslie Brown. I remember I shot her paintings and delivered the job in my one good suit and as I was leaving I got splattered with mud by a passing pick-up. The cleaning bill on my suit almost equalled what I was paid."

Fortunately, better things were to come, as Kroll developed his photographic style, drawing inspiration from his favorite lensmen, Man Ray, John Willie, Irving and Paula Klaw, Horst, and Pierre Molinere. Along the road to commercial success with best-selling books like *Fetish Girls* and photo assignments to take portraits of Ballanchine, Louis Kahn, and video installation artist Nam June Paik, there were the wedding assignments he'd rather forget and a project with Richard Kern to produce a photo book of Russia that never saw the light of day. His collaboration with Paik in particular was a defining moment as he accepted the challenge of taking photographs of Paik's installations, doing his portraits, and supplying images used in his art pieces. For pure photographic interest though, Kroll rates doing a photojournalist story for the *New York Times* on mercury poisoning among the Objway Indians in Canada as one of the best. He adds, "One reason for my interest was my interplay with Eugene Smith, who gave me advice for doing aerial photography."

Currently Eric is experimenting with natural light rather than his large collection of studio-flash equipment. He comments, "I did use Balcar strobes with a Chimera and a large boom for a hair light in my studios in New York

*This photograph was shot late at night in Kroll's New York studio. The model was a very tough and wonderful female, heavily tattooed. According to Kroll, she looked so elegant, yet she was street smart.*

*He wrapped her in pliable wire, thinking of early Paula and Irving Klaw shots. The hair and makeup were done by Dallas Allerman and the lighting was a Chimera softbox set on the floor very near to the side of the model.*

*80mm lens, Kodak TRI-X, 1/30th sec, f16*

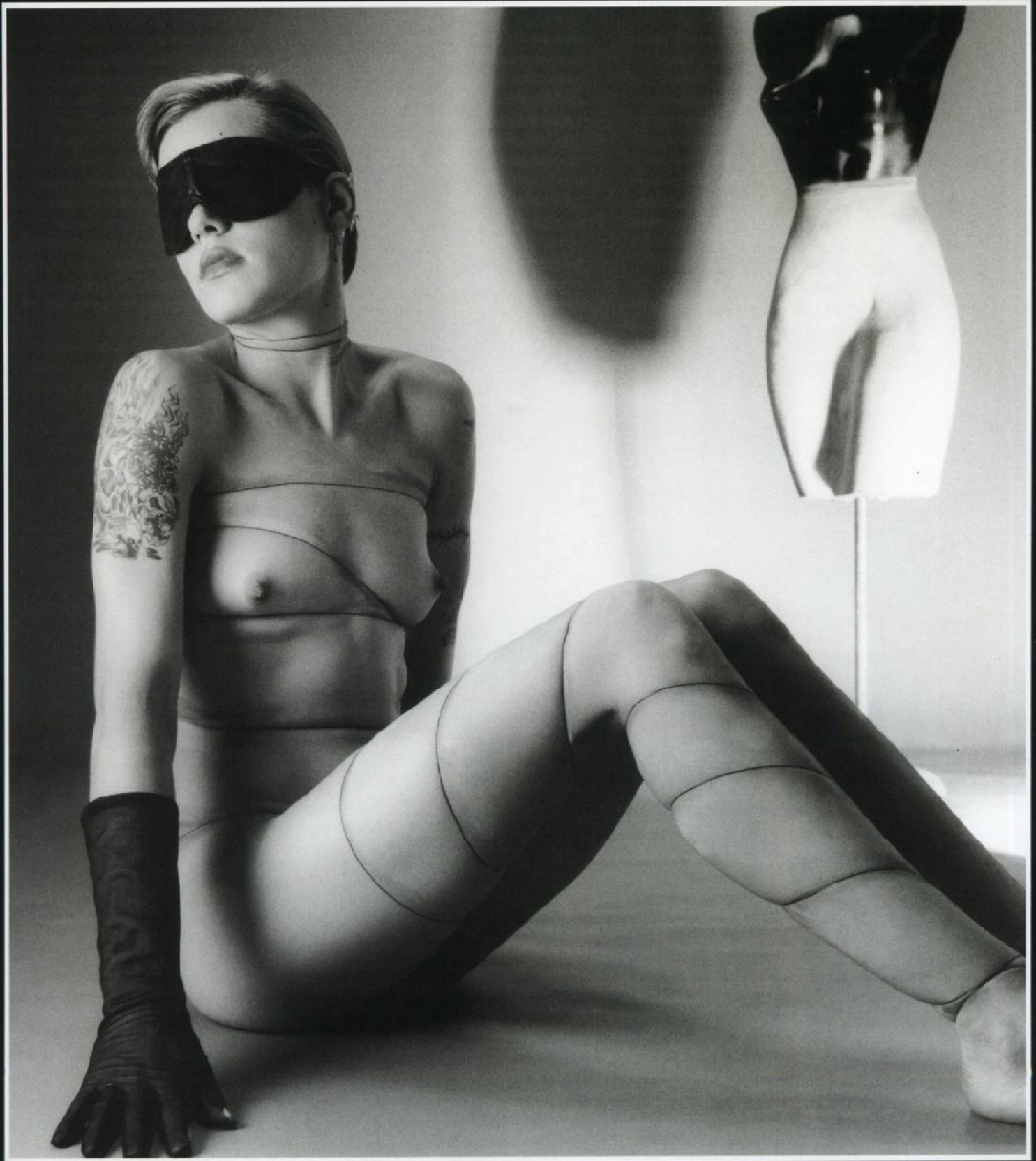





*(Above) This is classic Kroll combining sassy attitude with sexy vintage clothing. The positioning of the toes in the stockings is very Elmer Batters, although it wasn't until several years later that Kroll edited Elmer Batters, From The Tip of The Toes to The Bottom of The Hose, published by Taschen Verlag. This shot was taken using a Chimera softbox very close to the model and an umbrella positioned just above the hat using a boom. 80mm lens, Kodak EPN, 1/60th sec, f11*



*(Above) This photograph was taken in the public gardens just outside the castle grounds in Fontainebleau, France. This shot uses only natural light, and the model is looking beautifully apprehensive.*

85mm lens, Kodak Gold 100, 1/60th sec, f5.6

from 1971 to 1994. In San Francisco from 1994 to 2000 I used a Dynalite set and Omni lights. I still use Dynalites and from 2000 to early 2002 I used a combination of many Vivitar flashes with slaves. Now I use high-speed film and try to shoot by natural light." This marks a slight departure from the stark lighting and evocative form that has come to be seen as the signature of a Kroll photo.

Fortunately, success has brought creative freedom, and wedding assignments are now a thing of the past. Eric works only for himself. He comments, "I edit books of my choosing for the publisher, Benedikt Taschen. I also do books of my own work, run my own website at [www.fetish-usa.com](http://www.fetish-usa.com), and edit books for Taschen Verlag. I also have a new book that I have just handed into the publisher Greenery Press, entitled *Eric Kroll's Naughty and Nice*. It is 167 pages of my work over the last 14 years."

Motivation is not a problem for Kroll. "Everything I do is self-motivated and I am a hard worker. Yesterday I got up an hour before my muse and took some still-life photos of various objects lying around the house that I thought would be interesting to shoot. It never stops. I make my living photographing women but I sure like walking around the desert among the cacti, taking shots, although I can't imagine in this lifetime finding a market for those kind of pictures. It is a cliché, but I get the most satisfaction from doing my own work. I know when I have taken a good photograph and in particular I like taking photographs that hinge on the surreal. Recently I had been carrying around a sack of birdseed in my trunk with an idea for a photo. Back at my new house in Tucson my muse, Felice Arroyo, sat in the backyard wearing nothing but sunglasses and covered her naked body from her forehead to her toes first in aloe vera and then in birdseed, 'Girlfriend as Birdbfeeder.' Unfortunately no birds flew down from the trees and took a bite but the shot put an instant grin on my face."

*(Right) This photograph of a model wearing a prom dress in the Arizona desert was shot in late summer in afternoon light. Having lived in the area some 25 years before, Kroll was familiar with the late afternoon summer storms that hit Arizona. The delicate white material of the model's dress, with all its floating netting, works well against the heavy skies that loom over the desert.*

55mm macro lens, Fuji chrome 100, 1/125th sec, f11





*(Above) This shot pays homage to John Willie and is very loosely based on a drawing he made of a fantasy school scene. The models—twins—have been shot in Kroll's Victorian studio using his Chimera softbox that has been set on the floor with a second umbrella strobe on the opposite side. The models' outfits come from Kroll's own large collection of fetish props.  
80mm lens, Kodak EPN, 1/30th sec, f11*

## PATRICK LICHFIELD

"I try to avoid direct frontal lighting as much as possible," he says. "It makes the subject look flat. Back or side lighting seems to lighten the mood, and introduce depth to the shot."

Lord Lichfield is a cousin of the Queen of England, and resides in the 900-acre ancestral estate of Shugborough in Staffordshire. However, he is also Patrick Lichfield, a top fashion, social, and beauty photographer, with a sideline in glamour pictures for calendars that have received wide acclaim. While his recent work includes charity shoots of celebrities baring their backs, it is super-stylish calendar shoots that he is known for in the world of glamour photography. Whether it is a well-dressed, or half-dressed young lady in the grounds or in the dining room of a country house, or a more saucy pose in the back of a New York taxi, what makes Lichfield's shots stand out are the tremendous attention to detail and planning that goes into them.

For such a photographer of royalty, Lichfield didn't immediately get started in the photography business with a mountain of equipment and the best studio money could buy. Instead, he spent seven years in the army. After leaving he took up the job of a photographer's assistant and set about learning the trade from there until he felt he was proficient enough to strike out on his own, earning commissions on his own merits and skills.

The calendar shots are what most concern us here, and in these the army background of planning and logistics bore fruit. Whether they were in an exotic foreign location or not, a tremendous amount of planning went into them, and that was only half the battle. There also remained the question of the pictures themselves.

Such a project started with testing models. "I made a list of about 50 possibles," says Lichfield. "A process of initial elimination reduced that figure to ten. When girls came into the studio, I made videotapes of them going through a series of movement routines. We were particularly looking at their figures and at their faces. At the same time, we were working out what the theme of the shoot should be. Ideally we were attempting to select three girls whose looks suited the mood we were trying to create in the shots."

Simultaneously, in another part of the globe, a thorough survey was being conducted by Lichfield's location hunter, who documented possible places and sent photographs of them back to Lichfield.

After a lot of argument and discussion, the art director and Lichfield finally settled on a choice of girls and location.

His two assistants then got on with organizing the equipment—the cameras, lenses, film, and lighting gear. The models were sent off to a solarium for pre-tanning in order to minimize the risk of sunburn. The stylist assembled props and clothes, and the makeup man liaised with the team to ensure he was *au fait* with the desired look.

During the planning stage, the whole crew were trying to foresee—and therefore minimize—any problems that might arise. Film was clip tested to establish correct ISO ratings; digital camera backs and cameras were serviced, and the small amount of electronic flash equipment was tested, just in case it was required. Lichfield and the art director drew sketches of ideas they wanted to try.

By the time the Lichfield crew arrived at the location, they had a very clear idea of what they wanted. Inevitably, once they got there, things changed. The location itself may have suggested better ways of achieving an idea originally conceived in a London studio, or the weather may have precluded other picture ideas. However even if one idea fell by the wayside, another one would occur to the team while they were there. "Adaptability is vital for a successful shoot," Lichfield points out.

*This shot was taken during an expedition to Sicily to take photographs for a calendar. It is one of Lichfield's own favorites although it was not included in the calendar. It was taken at dawn, around 6 am, by natural light filtering into the cellar of the stately home in which Lichfield and his team were shooting. The strong geometric pattern of the model's body and limbs overcomes the gloom of the cellar, and provides an almost abstract image.*

50mm lens, Kodachrome 25, 1/30th sec, f2.8

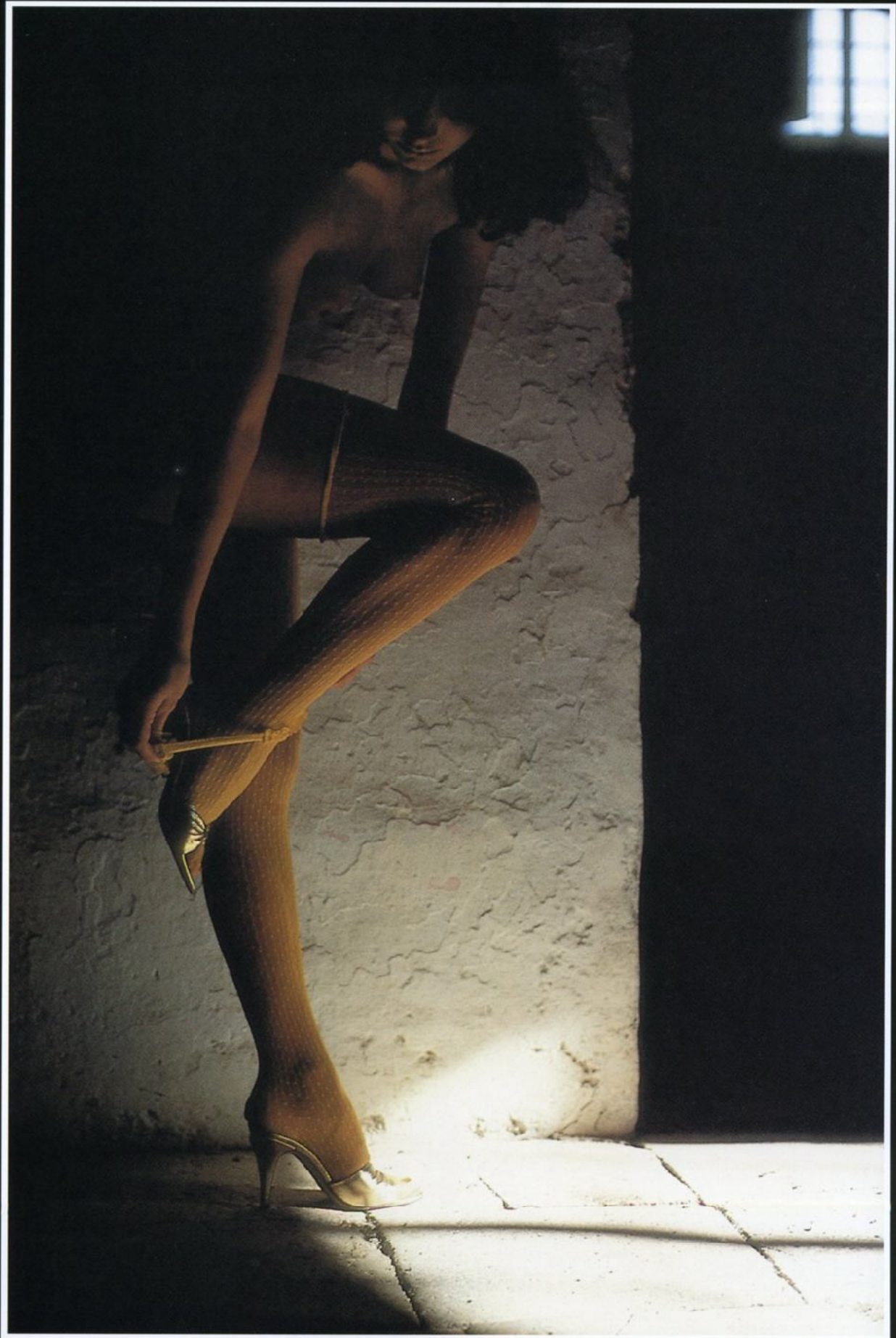



The look of each calendar is predetermined by Lichfield and the art director, and they try to avoid being labeled by going for a new approach each time. "You can't help acquiring a style," says Lichfield, "but I fight against it all the time. For example, I find that I am consistently attracted to symmetrical shapes in pictures. If I let my heart rule my head, I'd probably produce hundreds of pictures of perfectly symmetrical compositions, which would be adequate—and dull. So I consciously avoid symmetry, unless I can convince myself that it is justified and effective."

A clue to Lichfield's visual approach to glamour photography lies in the fact that he has no desire to use the extreme imagery that is currently popular with photographers working in the advertising field. "I think the cold,

impersonal look has been done to death," he says. He prefers to depict his women in a warmer, more human way. This means using photographic techniques that tend to flatter the models and which produce pictures that align with accepted male notions of femininity.

On location he was a fan of either 35mm or medium-format cameras, but recently has converted to using high-end digital backs, thus marrying the sharpness and quality of medium-format lenses with the convenience of digital.

On location, Lichfield likes to use available light as far as possible, even for interiors. He would rather use a slow shutter speed and a wide aperture than rely on electronic flash, which he says, "should theoretically look like daylight

but never does." Naturally, reflectors are an important part of the equipment Lichfield takes on location.

"I try to avoid direct frontal lighting as much as possible," he says. "It makes the subject look flat. Back or side lighting seems to lighten the mood, and introduce depth to the shot."

Lichfield himself is the first to give credit for the success of the calendar pictures to his dedicated team of helpers, but ultimately it is Lichfield himself whose name is attached to the finished product. It is his eye for an attractive, stylish photograph that sets the seal on the package.

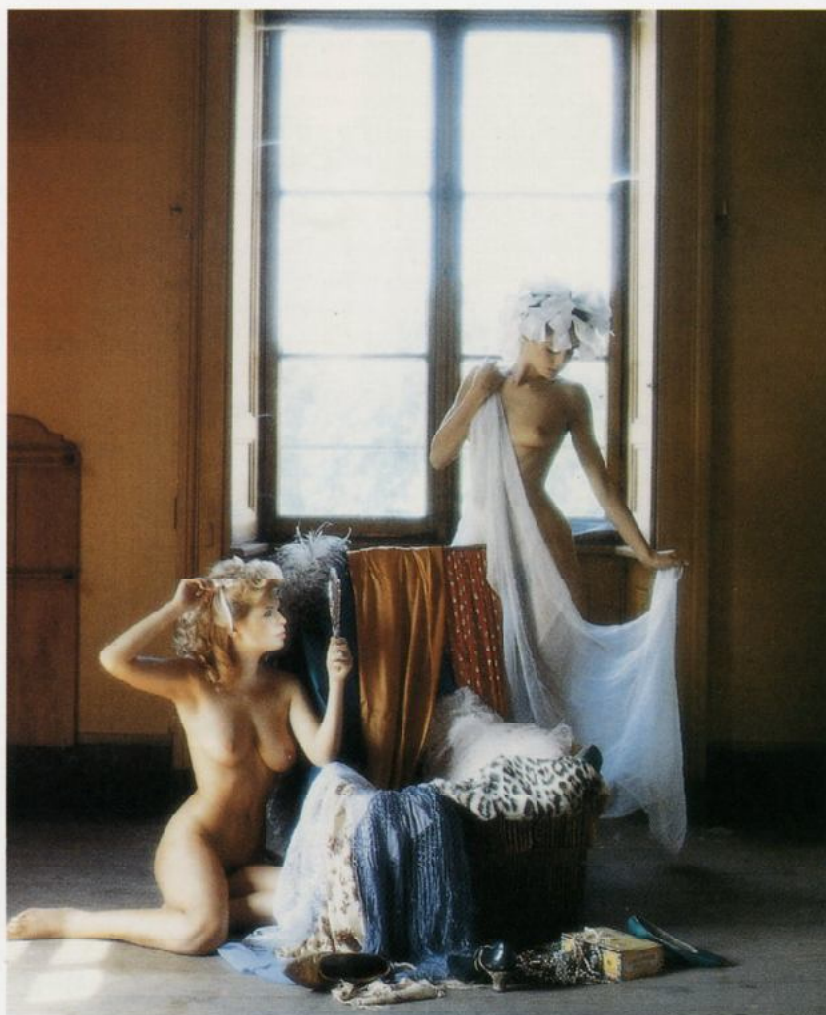

*(Left) Lichfield chose to shoot this picture against the light because he considered that this technique helped to tighten the mood of the shot. It also gave him the opportunity to allow the daylight to spill over the image, creating gentle diffusion. He used Ektachrome 200 film but pushed it to 400 in the processing. Reflectors were used to throw light back into the girls' faces. 35mm lens, Ektachrome 200, 1/60th sec, f4*

*(Far left) On location in the American "Deep South," Lichfield was looking for a shot that would establish the house and grounds that they were using for an entire calendar shoot. The idea was to produce a picture that set the scene and the tone for that year's calendar. The model's naked bosom is the only aspect of the scene that is out of place and therefore draws the eye. Lichfield used a 2¼ sq in camera for the shot, employing a 150mm Softar lens to give the image a diffuse feel. 150mm lens, Ektachrome 64, 1/125th sec, f8*



# CRAIG MOREY

"One thinks one has an understanding of women and eroticism after twenty or so years in this business, but I learned how little I know when I started working in Thailand."

Craig Morey started out by shooting a mono series for *Penthouse Letters* when the professionals proved too expensive and now has studios, publishers, and commercials knocking on his door for anything from regular glamour to artistic nudes, to a collaboration with Japanese bondage expert Midori on a book titled, *The Seductive Art of Japanese Bondage*. A wide-ranging talent and the ability to appreciate the female form in all manner of settings have made his work commercially successful and much sought after.

When studying at Indiana University with Professor Henry Holmes Smith, nothing might have seemed more unlikely as Morey struggled to find his own place in the photographic firmament. Craig comments, "I was a typical photography student. I learned the basics without much trouble and had an innate desire to make pictures—but my goals were not defined. I didn't know what kinds of photographs would be likely to launch a great career as a fine-art photographer. I tried portraits by candlelight. I tried turning out the lights and making pictures with a flashlight. I tried making imprints with Vaseline on my hands and developing the paper in laundry detergent—all ideas I got from the *Popular Photography Annual*. They were very interesting directions, but nothing came from them, except a really rather pathetic undergraduate student portfolio."

Having tried copying all the big-name photographers of the day—Adams, Weston, Siskind, Kertez, and Cunningham—his work didn't suddenly become inspired but it did lead to a greater understanding of how to create a picture. Although his college professor wasn't overly impressed, Morey credits him with inspiring the

creative thought process that all truly great photographers need. He recalls, "Smith was the first person I had heard of with any real insight into art and artists and the creative process. He was a great talker—not that I always understood what he was saying. What I did eventually understand was what he wasn't saying. He wasn't saying that my composition was bad, he wasn't saying I shouldn't try to be Ansel Adams, he wasn't, in fact, saying much at all about the pictures. He was talking about art in general, about the creative mind, and about what it feels like to look at a great image—a photograph, a painting, a drawing, any kind of image. He seemed to care very little about whether we got our exposures correct or whether the prints were done properly. He was always more interested in "why" than in "how" we had made our photographs. Although he didn't harshly critique my work, both he and I knew my heart wasn't really in the images I was producing. He encouraged me, perhaps because he knew I had the enthusiasm if not the promise of greatness."

This enthusiasm landed Morey his first involvement with the photo art world when he became director of San Francisco Camerawork (San Francisco's first non-profit photography gallery) in the mid 1970s. As a result he got acquainted with many fine-art photographers and museum people on the West Coast of America. After becoming rather frustrated with organizing exhibitions for other photographers, Morey decided that, instead of pursuing a career as an art bureaucrat, he wanted to actually make pictures. And, he hoped, get paid for it.

His technical grounding in photography came about through being an assistant—first, in a large assembly-line studio where they shot everything from

wine glasses to underwear, and later, in the studios of various advertising and fashion photographers.

Then, sometime in 1987 he got a call from the art director for *Penthouse* in New York. This was quite a thrill for Craig—not because he loved the magazine, but because it was the first time he had received an unsolicited call from an art director. It seemed a friend of one of the old Camerawork board members had mentioned his interesting leg photos to her. She was working on one of the smaller publications owned by the company, called *Penthouse Letters*, and she wanted to bring a more artistic look to some of the features. She asked to see a portfolio of his work, which he quickly sent, and over the next few months, *Penthouse* bought the rights to run about a half dozen of his photos. Craig was obviously delighted—he wasn't making a lot of money from it, but it was great to see his work in a national publication, even if it wasn't exactly *Aperture* or *Vogue*. Also, for the first time, he started to think about pursuing commercial work with his art portfolio.

When eventually that art director was replaced by another, it looked like this profitable little venture had run its course. But then the new art director called Morey to ask him if he could shoot something in the style of Ken Marcus and Robert Mapplethorpe as they were too expensive. She was looking for a photographer to shoot some nudes in black and white of an inter-racial couple for a feature in their *Penthouse Letters* magazine.

Morey agreed without hesitation, and without asking what she might mean by "that style," and how much they intended to pay. He wasn't about to question her and could almost see the



*The brief for this photograph was to shoot something rather erotic but very fashion oriented. Morey has attempted to use the female model in front to mimic the pose of the muscular man behind her, and to shoot it so that she almost becomes part of him in the image. The lighting setup consisted of a high softbox for the main light, with reflectors off to the side. A small light was also positioned at the back to create a glow behind the models. Morey used chrome film balanced for tungsten lighting, which turned the colors rather intense shades of purple and pink, since the strobes were balanced for daylight. A red-gel filter was also added to the rear light. 100mm lens, chrome 100ASA, 1/250th sec, f8.5*



door to a new career opening before his eyes.

As Craig now recalls, "When the gravity of the situation hit me, my elation soon turned to panic. I certainly didn't want to let on that I was such a novice on the business end of the discussions, for they'd quickly figure out that I was pretty much a novice on the other end of the equation as well. I continued to discuss ideas with the art director, and somehow bluffed my way through. She seemed convinced that I knew what I was talking about, and after a while I was almost convinced myself."

However, it soon became apparent that the art director assumed Morey had a host of models to choose from, which left him in the position of having to find a good model on a small budget, and in a limited amount of time. "There was no point in contacting the so-called legitimate model agencies," Morey says. "They wouldn't want to be associated with the *Penthouse* name, and, more importantly, would want a fortune to have one of their models pose nude. Fashion models, even at that time, charged at least \$150 per hour, and usually double or even triple that amount for lingerie or semi-nude



work. I expected my shoot to take at least three hours, and to involve full-frontal nudity.

"Fortunately, while the *Penthouse* name was mud in some circles, in others it was magic. I knew I would need to hire people who were used to posing naked, so I began calling a few alternative model sources. There were several agencies specializing in stripping telegrams and erotic entertainment, and even though the budget for the shoot was small, they all jumped at the chance to have one of their dancers appear in *Penthouse*. It wasn't long before I had two models chosen and approved by the art director.

"My biggest fear on that first shoot is still one of my primary worries today—will the models actually show up? I've been fortunate that on only a few occasions have I been forced to cancel a shoot due to a no-show—and on this first shoot for *Penthouse*, I was extremely lucky. Not only did the female



*(Far left) This image is from one of Morey's most recent projects—a series of nudes shot in Bangkok. This will eventually become a book, and is currently a large portion of his website. Joom, the model in this picture, was introduced to Morey by his translator and, like most of the Thai models he photographs, did not speak much English at all. However, she saw two of his earlier books and so understood more or less the kinds of pictures that Craig wanted. This session was shot in a rented hotel suite during his first visit there in 2001. The lighting is a portable studio strobe set up and the camera is Morey's faithful Hasselblad. 50mm lens, Kodak TRI-X, 1/125th sec, f5.6*

*(Left) The art director at Penthouse called Morey with a request for some black-and-white images of a mixed-race couple, both with good athletic bodies. Morey had just photographed the female model for another project, so he knew she would work well. He was fortunate enough to then find a black weight-lifter strong enough to pull off this pose that he'd been sketching and trying to compose for a few months. The same set up was shot for three or four rolls, until the male model was exhausted—he ended up with such a cramp in his arm that he couldn't bend his elbow for an hour after the shoot! This was photographed using a standard softbox and a Hasselblad.*

*120mm lens, Kodak PLUS-X, 1/250th sec, f8*

*(Below) This photograph has been taken from the Penthouse "Erotic Dancer" series. As this model has such a classic shape, Morey wanted to accentuate the curves of her back and buttocks. She's lying on a sheet of plywood covered with one of Craig's backdrops and propped up on some blocks. This shot was again taken using a Hasselblad.*

*120mm lens, Kodak PLUS-X, 1/125th sec, f8*



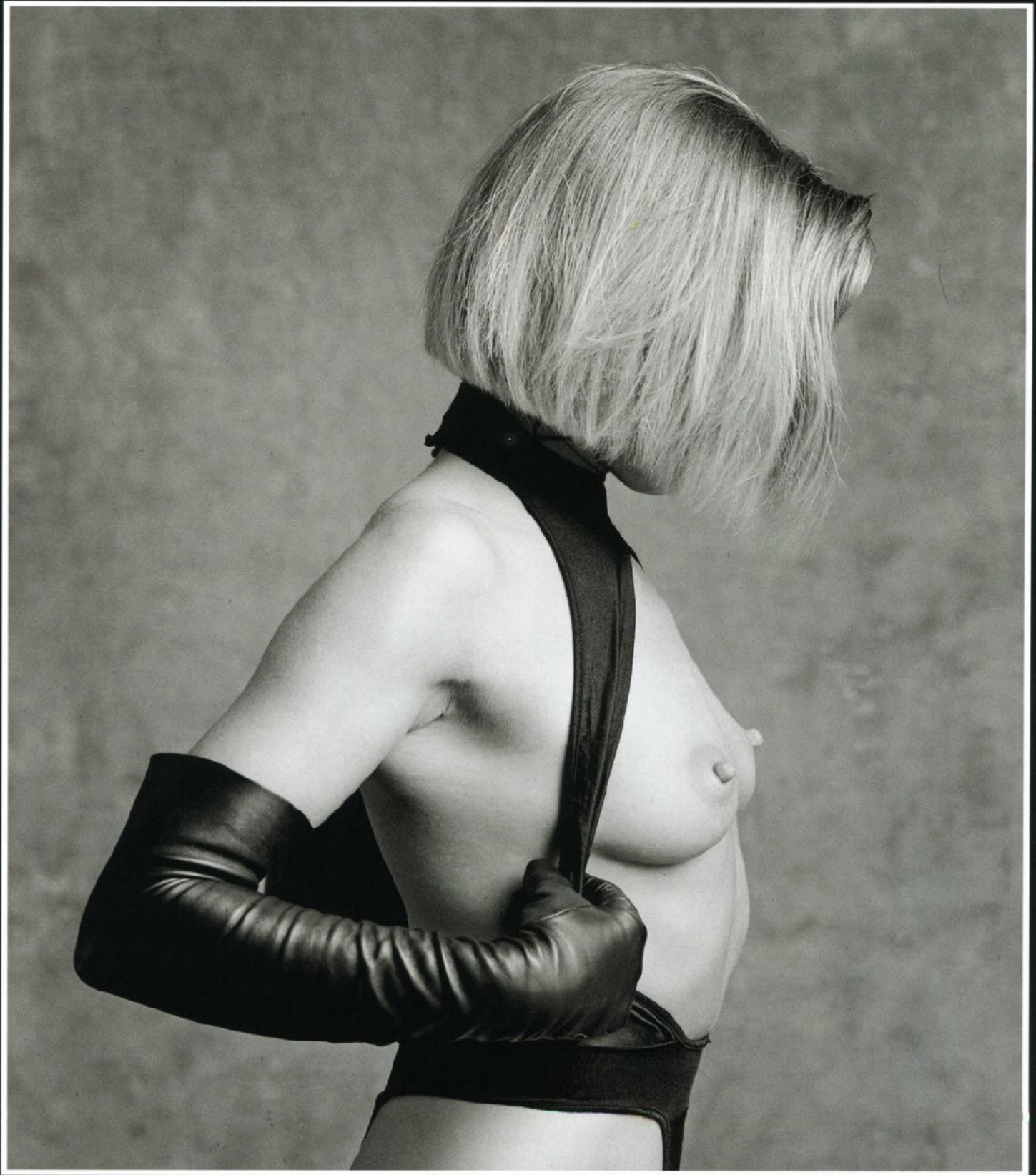

model show up early, she also brought the male model with her. I had made some drawings and notes ahead of time, so I wouldn't forget certain shots, but I was also counting on some spontaneous inspiration, as well as the photographer's best friend—Polaroid.

"Part of my confidence about being able to get the lighting right came from my brief stint as an assistant in a commercial still-life studio. I learned there that even the most atrocious image can be fixed if you just pay attention to your Polaroids and adjust the lights until it looks right.

"I started by shooting a Polaroid. To my utter amazement, it looked almost perfect. From that first Polaroid on, we had a really collaborative and creative afternoon. I showed the models my sketches and they tried their best to duplicate them on the set. We moved the lights in closer and higher, for some added drama (darker shadows), but for the most part, the lighting did not change. I paid very close attention to the Polaroids, left the camera settings unchanged most of the time, shot the whole session with one long lens and concentrated almost entirely on what was going on in front of the camera. That first session for *Penthouse*, which I pulled off by the seat of my pants and almost no budget, set the tone for the next 20 years of my career."

Over the past 20 years, Morey has had a half dozen different studios. The ideal setup is the studio attached to the home, because he tends to work long and odd hours. The shooting space is about 1500 square feet—he demands a model-to-camera distance of at least 20 feet to get the full range of images from a session. Morey uses either Norman studio strobe equipment, or Dynalite, but almost any good studio lights are acceptable. He's also very partial to Hasselblad cameras, for a number of reasons; they are easy to use, sturdy, dependable, and it's easy to find rental parts when necessary. He hasn't been blind to the advance of technology though. "I've just started to use digital cameras. The Nikon D1 is quite stunning, both in performance and cost, and the Olympus E-20 is also quite good. I have just completed a three-week shoot of nudes in Thailand and shot with both the traditional setup and with a digital system. I used three 256 mb memory cards and we downloaded the images into the G4 Titanium Mac and then burned CDs—I felt like I was in a science-fiction movie!"

These days Morey is often his own best client. He does commercial jobs of course, but for his own work—the black-and-white nudes—he creates and completes the sessions himself and then markets the photographs to collectors and publishers.

Morey is also getting assignments for this kind of work from some off-beat publishers, as can be seen by his most recent book collaborations including *The Seductive Art of Japanese Bondage* (Greenery Press), where he got to work with the infamous bondage expert Midori, and *I Am My Lover* (Downthere Press), in which he photographed women exploring their own bodies. He also does a lot of commissions for models who've seen his work and want to be photographed, or for husbands who want to have their wives photographed.

It was his flexibility and willingness to explore new avenues that took Morey on the trip to the Far East and Bangkok. He admits that this has been extremely interesting and eye-opening. "I have had wonderful sessions in my

work in the US, such as my Studio Nudes series, but learning how to relate to women who don't come from a Western cultural background, or speak my language, as well as working away from home, is both exhilarating and terrifying. One thinks one has an understanding of women and eroticism, after 20 or so years in this business, but I learned how little I know when I started working in Thailand. The women there are very different to work with, and their beauty and sexuality is of such a different nature, that it's almost impossible to describe. It's had the effect of re-awakening my early desires to make this kind of work, and has expelled a little of the jadedness that one develops after seeing countless women naked."

While it was his *Penthouse* work, published in the early 90s, that became known as the Studio Nudes series and is by far his most known and recognized work, he has continued with this theme, which has appeared in many books, magazines, and websites. These classic nude studies form part of the Morey style and he himself asserts that the canvas backdrop, black-and-white imagery, and soft-lighting technique would be the technical specs that mark his work. In reality though, the look of the pictures has as much to do with a vision of the model as an icon of beauty and eroticism. He often places the model on a platform, or pedestal, and since the background is a muted gray and rather undefined, the woman becomes statuesque or symbolic.

Of all the women in the world, who would Morey like to work with and photograph? He comments, "If I had the opportunity, it would be someone you would not ordinarily expect to see in that setting—perhaps someone like Natalie Portman, Sandra Bullock, or Salma Hayak."

Looking ahead, Craig would like to continue his work in Thailand, perhaps take a trip to Eastern Europe, do a series on body modification, and spend a great deal of time sitting in front of the computer.

(Left) This shot is taken from Morey's first monograph, *Studio Nudes*, published by *Penthouse Books*. The model had brought quite a lot of black leather gear to the shoot, so Morey took many rolls of film of her in gloves and rather severe outfits. This particular shot is designed to show her very prominent nipples, and the fact that her face is hidden adds some mystery and makes the viewer focus on the breasts.

120mm lens, Kodak PLUS-X, 1/250th sec, f8

# TREVOR WATSON

"If I didn't earn money from this, I'd be doing it anyway."

Trevor Watson's name is well-known in the world of photography. Whether you are a fan of his work or not, his output over the last ten years in particular has been right at the forefront of the movement that has taken fetish and highly-stylized, glossy images to the front of glamour photography. A Trevor Watson book is, in itself, a visual treat with spectacular style and is an exercise in restrained excitement and subverted pleasure. It didn't start that way though when Watson left school aged 15, with little experience and no photographic training. Nevertheless, the desire was there and when, ten years later, he bought a camera from a friend and started taking photos, he decided that this was what he'd always wanted to do. From humble beginnings where he built a darkroom in his studio apartment and learned to print from a book by Bill Brandt, he now uses state-of-the-art equipment in a custom-converted old furrier's shop in London.

To his regular stable of Nikon F4s and Bowens flash, Trevor has added a Nikon CoolPix 5000 and, most recently, the digital SLR, Nikon D100. He uses a Nikon CoolScan 4000 scanner to turn his negatives into digital and a Mac G4 finishes the digital processing. Test shoots are done digitally, but for top-quality work, it's film first, then scanning.

Influences such as Fellini, Fritz Lang, and Buster Keaton all demonstrate where the love for black and white came from, and the work of Brandt, Gilles Berquet, and John Willie led to the development of a style that landed his first major commercial opportunity for the Skin Two rubber-clothing catalog. Eschewing the traditional photographer's lament of working for other people, Watson primarily produces work that he wants to create, and then looks for a market for it. Where the two interests intersect there is a happy meeting of minds, such as the current project to produce a book called *Kink* for the Erotic Print Society. However, when he has offers such as being invited by a millionaire to spend two weeks photographing his birthday celebrations at an exclusive resort in Bali, Watson knows when to stop doing it for his art and start doing it for the money.

Fortunately the two are not mutually exclusive, as he discovered after shooting a stylish male-nude poster for Athena. It sold 175,000 copies and cemented his name in the annals of risqué photography. That name is now synonymous with, as Trevor himself admits, mainly black-and-white, interesting, and often symmetrical composition, moody or dramatic lighting, and sexually challenging or

controversial subjects. This isn't a field he decided would be worth ploughing just for the money, either. He shoots almost everything for himself anyway. His work and his personal photographic preferences and interests are exactly the same. As Watson remarks, "If I didn't earn money from this, I'd be doing it anyway."

Given the constant need to keep money coming in, Trevor is a busy man. He has just released a new book of super-sexy photos called *Exposed*. The cover image featuring a model, bare backside protruding out of a car, is instantly recognizable as a Watson photo and will have collectors scrambling for their checkbooks.

Even though Trevor uses film for his current work, he recognizes that the digital revolution opens up photography for many more people. He foresees a lot of great photos getting exposure via the internet, from people who would otherwise have no access to the closeted world of the printed media and exclusive galleries. And despite his success and undoubted stylistic talent, he's still thankful that for the last 20 years he's had the opportunity to turn his ideas for images into reality.

*This was taken recently in Watson's studios with one of his favorite models. It was a test to see what the pink tutu, pink knickers, and pink stockings would look like together. The model was lit by a large softbox about 4 ft (just over 1m) above the ground, with the camera below it. This was taken with a Nikon D100 which Trevor was trying out.*  
85mm lens, Nikon D100 digital, 1/125th sec, f8







*(Right) A typical Watson studio shot. The model is sheathed in translucent material, stretching it while she looks back at the camera. The scene is lit by two flash units for even lighting and a simple, graphic shot. 35mm lens, Kodak PLUS-X 100, 1/125th sec, f16*

*(Below) Shot in a borrowed Jacuzzi, the model is heavily made up and stares at the camera while her buttocks bob to the surface amidst the foam and water. Lit from above and the front by studio flash, the soapy water and her rounded shape are highlighted. 28mm lens, Kodak TRI-X 400, 1/125th sec, f8*



*(Left) Some photographers go to exotic locations, others to expensive ones. Here, Watson went to the toilets of the "Supper Club" in Amsterdam, dressed his model as a nurse, and hammered her with flash lighting. 28mm lens, Kodak TRI-X 400, 1/125th sec, f8*

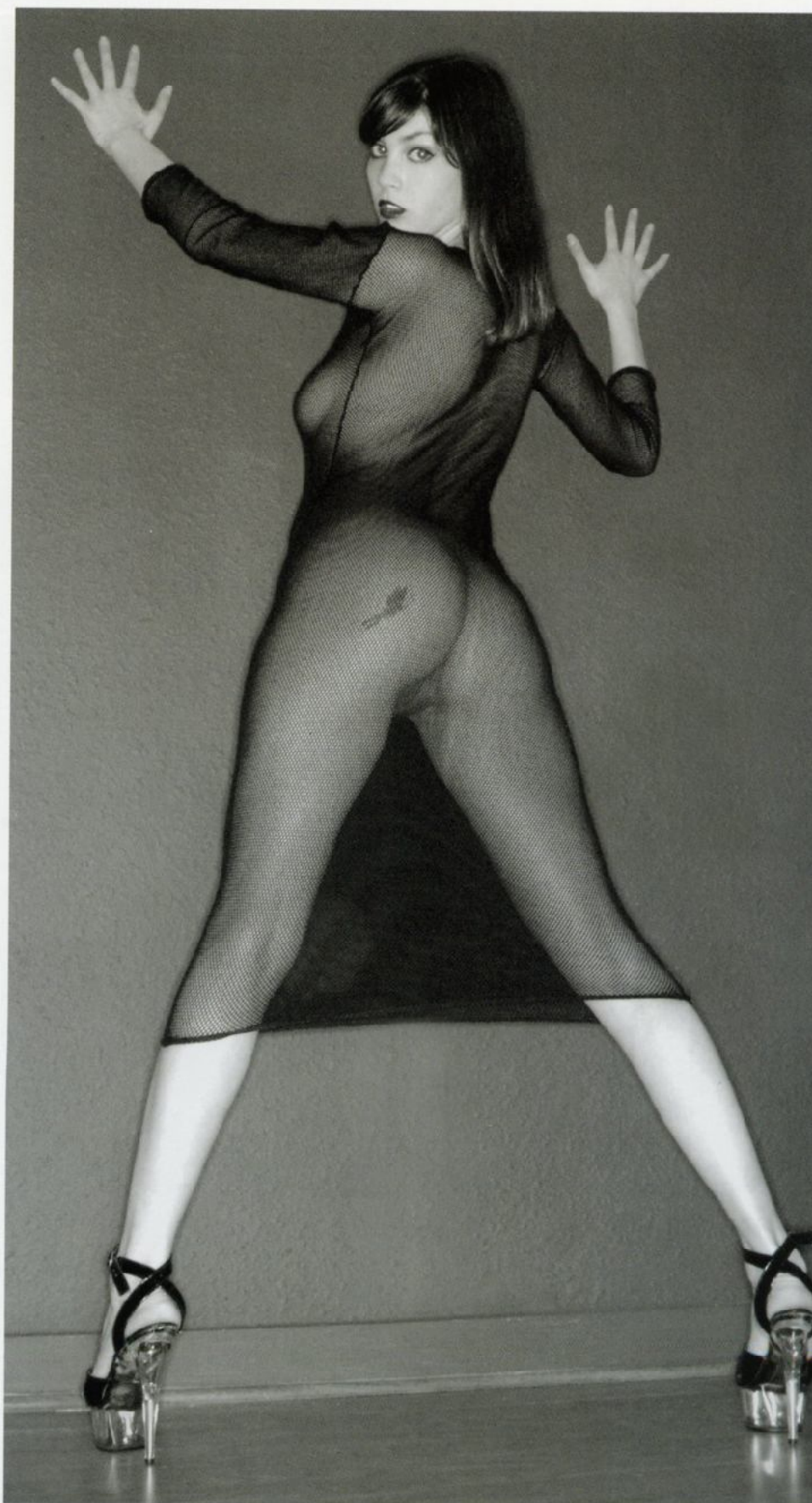

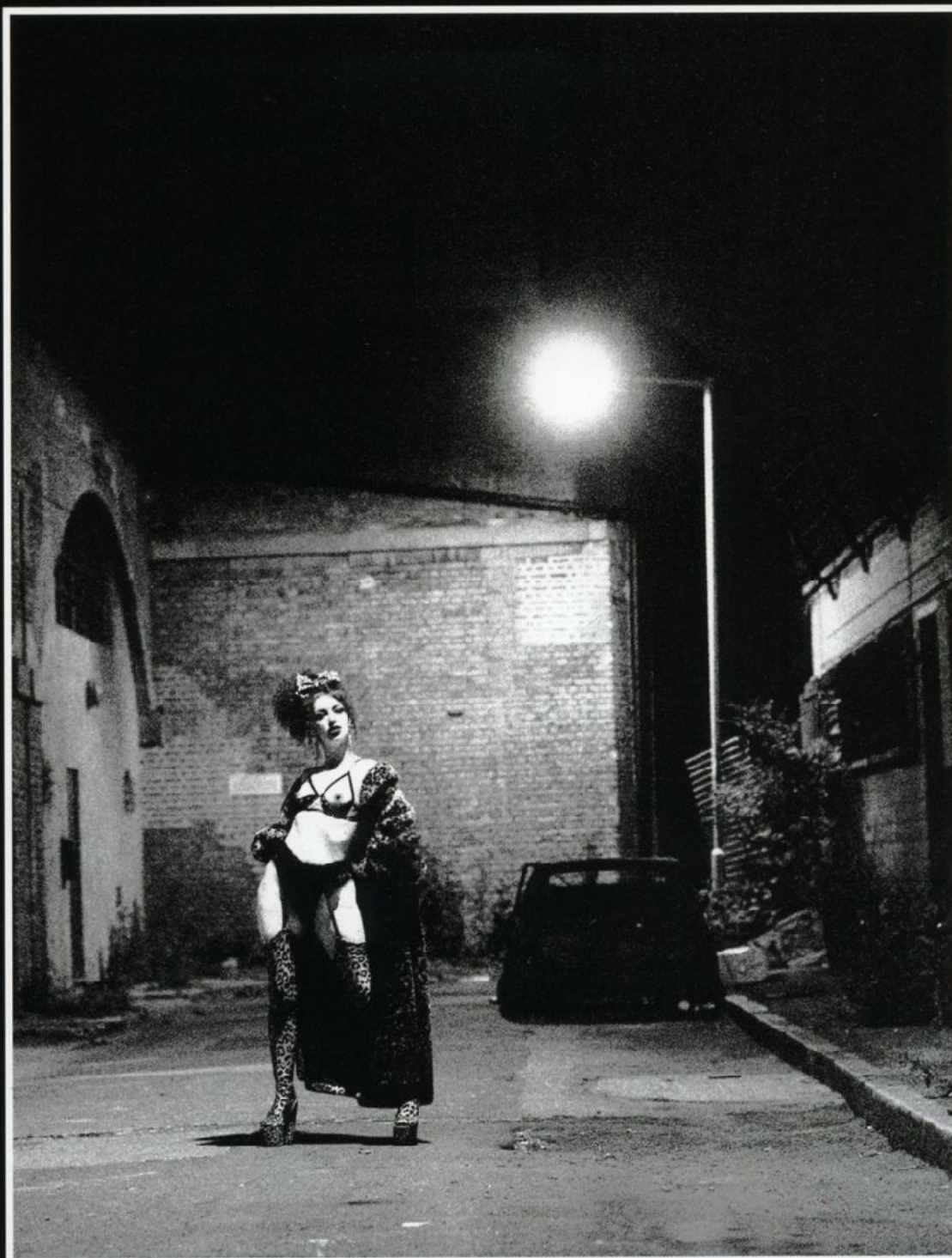

*(Above) Here, the model is dressed like a hooker and poses in a London backstreet at 3 am. This was shot for fun on TMax 1600 film and then processed at ISO 64000 just to get the extreme grittiness.*

*35mm lens, Kodak T-MAX 1600, 1/15th sec, f5.6*

*(Right) The obsession with buttocks and high heels comes to the fore in this studio shot using natural light. The model not only had rounded buttocks, but was also very thin and accentuated the pose by leaning forward and curving her spine as much as possible. Not very comfortable, but a striking result.*

*80mm lens, Nikon D100 digital, 1/250th sec, f5.6*



# BEN WESTWOOD

"I create from my own sexual fantasies—no one can copy that in the same way."

A cutting honesty and simple pleasure in creating erotically-charged, colorful images is how Ben Westwood describes his photographic output today. The son of outrageous fashion designer Vivienne Westwood, Ben discovered photography after taking a two-year furniture design course and a one-year foundation course in art. It was this artistic element that taught him about 35mm cameras and black-and-white developing. Having had his interest in photography duly activated, he tested the waters of glamour photography by hiring models from agencies for the sole purpose of doing test shots to see what he could achieve. At first he used tungsten lighting, but seeking the purer color tones that are his trademark, he upgraded to an Elinchrome studio flash system. Ordinarily, he concentrates on composition and so tends to use just one or two flash umbrellas, seeking out real locations rather than the sterile environment of the studio.

While initially producing work for the top-shelf end of the glamour market, Ben has been branching out by producing less explicit and more stylized photography that has been taken up by book publishers. His website, [www.benwestwood.com](http://www.benwestwood.com) covers all his output from the

inoffensive to the hardcore. While he declines to mention any influences or favorite photographers, he does offer that his motivation is an obsession with justice, honesty, and the truth. He rates doing portraits, marketing his photos, and undertaking exhibitions as his favorite part of the photographic process, particularly projects that take him outside the UK, where he is based. Perhaps with tongue firmly in cheek, reflecting the same subversive humor often found in his photos, Westwood claims that the least interesting part of the job is straightening lingerie and fastening suspender clips to stockings. Not to mention filling in tax returns. He also doesn't have much time for speaking with people in the fashion industry, and finds scanning negatives into the computer a tedious necessity.

What makes a Westwood print his own? Ben offers this: "I create from my own sexual fantasies—no one can copy that in the same way. My photos are deliberately shot to be very colorful." An exclusive voyage into those sexual fantasies will be available for the general public when Edition Skylight of Zurich releases his next book at the end of 2003.

For all the talk of private fantasies though, Westwood declines to nominate

anyone famous he'd like to feature in the photographic version. Ben likes, "Anyone sexy. Models and celebrities are too worried about their reputations." He adds, "Everything I shoot is for myself. It's the only way to be original. I just hope that other people like it, otherwise I can't afford to do it."

At the end of the day it's down to the vision of the photographer, according to Westwood. "The world is full of people with cameras. Some are technically better than others but this makes no difference. It is what is photographed and why that is important. If it has some relevance to everyone's day-to-day life and is not trying to push something rubbish down people's throats—like advertising which is where the money is, apparently—then it can have a human/social relevance. But only if the photographer is honest and puts his or her heart into it."

*Shot on Kodak Ektachrome E100-VS, this uses the honeycomb fitted flash head to direct the light and bring out the highlights on the model's PVC clothing. It was shot with the Nikon 24mm wide angle lens to distort the perspective and add humor to the obvious glamour potential of the scene.*

24mm lens, Ektachrome E100-VS, 1/64th sec, f8





*(Above) The author entitled this shot Private Peek. The use of the mirror adds a sense of mystery and intimacy to the scene—as if the model is not aware of the camera.*  
24mm lens, Ektachrome E100-VS,  
1/125th sec, f5.6



*(Right) This was taken in the studio using a studio flash head fitted with an umbrella.*  
35-70mm lens, Ektachrome E100-VS,  
1/125th sec, f16



*(Above) This was shot on Westminster Bridge in London using E100-VS slide film for the very saturated colors it gives under all lighting conditions. It was shot in natural light without any aid of flash. 35-70mm lens, Ektachrome E100-VS, 1/64th sec, f8*

*(Right) The idea of this shot was to get an abstract close-up, concentrating on color and the disembodied form. It was shot using a studio flash head fitted with a honeycomb filter to direct the light. 35-70mm lens, Fuji RVP 100ASA, 1/125th sec, f16*

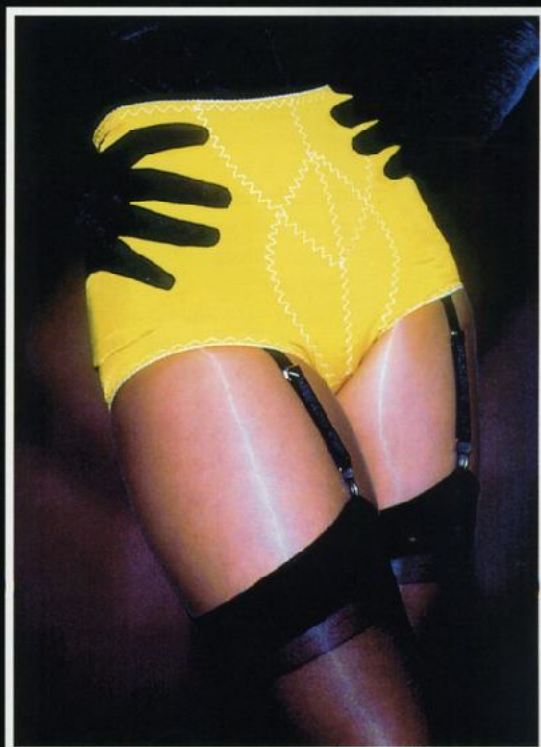



## TREVOR AND FAYE YERBURY

"It's all about the heart telling the eye to tell the finger to press the shutter release, and that's something you cannot teach anybody, it must be inside you from the beginning."

From portraits of the Queen, to artistic nudes of an 18-year-old girl experiencing her first summer as an adult, the work of husband-and-wife team Trevor and Faye Yerbury is as varied as it is polished, professional, and artistically appealing. The Yerbury name is well established in Edinburgh, Scotland, for the simple reason that Trevor's great grandfather founded the studio in 1864. Trevor is the fourth generation of photographic-minded Yerburies and went straight from school to the business as an apprentice when he was 17 years old.

These days, the studio itself is located in the Yerburies' house, a four-story Georgian town house in a world-heritage site in the center of Edinburgh. The studio itself is 18 x 26 ft (6 x 9m) with two full sash windows for available light shooting and Bowens softboxes for flash. Cameras range from a treasured gold version Hasselblad, a 10 x 8 in Wista, a Nikon F100, and Trevor's current favorite, a black Contax G2. A Nikon scanner is used to import the negatives and transparencies onto the computer and a special-edition range of prints uses watercolor paper for fine-art output. Equipment is not the key to the Yerburies style though. Simplicity is their byword, with less time spent fiddling around with equipment and more time talking to the sitter.

That comes with an intimate understanding of people, lighting, posture, and the equipment. Few of which Trevor had when, as an apprentice, his father fell ill and he had to complete the assignment of photographing the President of the Scottish Rugby Union under tungsten lamps with a 5 x 4 in Linhof studio-plate camera. Fortunately he had been well-schooled and the prints were a success, and also just a foretaste of the

sort of client list that most people could only dream of. Over the years the Yerburies have photographed the Queen, Princess Anne, Billy Connolly, and Amanda Holden, although Sir Sean Connery is still on their wanted list.

One of their best shoots was photographing Billy Connolly for the BBC, who sent an entire film crew to set up tracks in the studio, which took up half the day. Faye and Trevor had Billy to themselves for four hours—an experience not to be forgotten. That was back in 1995, yet last year, when Trevor bumped into him at a hotel in Aberdeen, it was instant recognition and remembrance of the day. Trevor asserts that Connolly was a true gentleman.

The Yerburies are unusual in that they work together on shoots, including the nudes. Indeed, from being an assistant to Trevor, Faye Yerbury is now a polished photographer in her own right, tackling male nudes. Trevor comments, "A female model feels much more comfortable if there is another female present on the shoot and it helps immeasurably to have Faye's input and help. However, when Faye is shooting a male nude I tend to stay clear as males seem to be considerably more embarrassed when another male is present. Funny old world.

"Most of the work we do now is on the nude although we still accept a limited number of wedding commissions each year, and of course now charge accordingly. Apart from that, we continue to undertake portrait commissions from all over the UK, mostly in the studio here in Edinburgh. Clients can vary from royalty, down to just an ordinary housewife who would like a stunning portrait of herself."

Ultimately it's the people themselves that interest the Yerburies and their photography becomes a social study as well as an exercise in producing stunning prints. It's a part of the job that fascinates Trevor, who remarks, "Photography, especially portraiture, allows us access to a huge variety of people that come into our lives and while they are in the studio we have a unique opportunity to find out what they do and what makes them tick. So be it a garbage collector, a high-court judge, or an actor, they all have a story to tell. I recently did a portrait for our festival exhibition this summer and discovered that the sitter, as well as being a top bagpiper, has a complete fascination for the Wild West—so much so that I got him back that same afternoon wearing his complete outfit in the guise of Wyatt Earp. His replica outfit came complete with guns that he had had made in the States to match the originals, and of course the Marshall's badge. The fact he is 6'3" and has grown a matching moustache did help."

Trevor maintains that portraiture is 50 percent technical skill and 50 percent people skill. He prides himself on being able to talk on most subjects and at most levels. The important thing is to get the sitter talking about themselves. Most people love to talk about themselves. When it comes to photographing nudes the Yerburies look for a variety of things, sensitivity, the mood, feelings, innocence, and the gently erotic.

The current project list is as interesting as it is varied. Their Edinburgh Festival Exhibition consists of seventy 50 x 50 in black-and-white portraits of Edinburgh citizens. The exhibition is simply called *Citizens*. Part Two is the following year. The location is the largest venue space in Edinburgh, the entire Ocean Terminal



*This was photographed at the model's own house in Scotland. Her girl-ish hair and fresh face suggests an innocence and youth. This contrasts with the intensity of her stare. The natural curves of her body are set off by the horizontal linearity of the steps.*

150mm lens, Ektachrome 200, 1/125th sec, f2.8

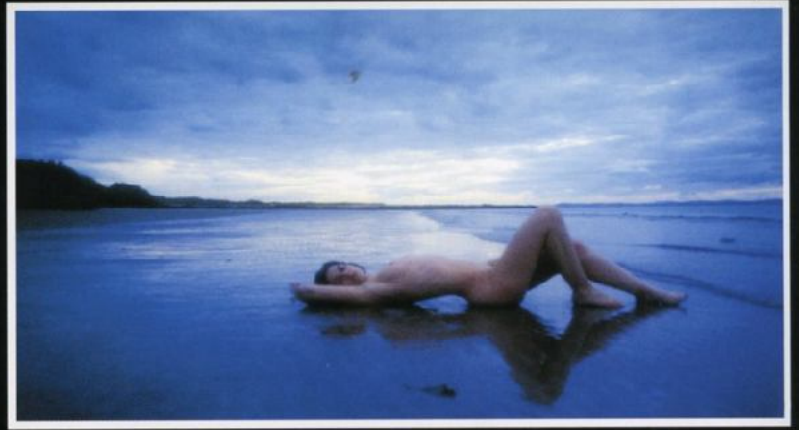

complex. This is Europe's biggest dock-side shopping mall, designed by Sir Terance Conran, and recently hosted the cruise ship, The World. The next will be a beautiful book called *Victoria's Summer* and will consist of nude images shot over the course of this summer of a young girl who has just left school, turned 18, and is experiencing life. Each image will be accompanied by some text written by Victoria of her feelings, emotions, and awakenings as she enters adulthood. Following that is a project for charity in which they will be photographing the beaches and seas around Scotland, all in a very gentle and soothing mood. Here each image will be accompanied by the thoughts and emotions of various Scots, some famous, some not so, as to how they feel when they are down by the sea. The Yerbury's may be a generation-old studio but that's not to say they don't embrace new technology. They are currently developing their website, [www.yerbury.net](http://www.yerbury.net), and producing another tutorial video. Their first one is selling well and can be

ordered through the website. Looking ahead, Trevor is keen to get involved in directing. He has already dabbled with it and is hoping that that side may develop. In the meantime, concentrating on creating images is what concerns them. Trevor concludes, "You know that you must be doing something right when the public buy your work. It's a great kick to think that our work hangs on people's walls around the world and now, with the internet, our work has become accessible to a worldwide audience."

"My favorite saying is that you cannot tell or teach anybody interested in a career in photography or a fellow profession. It's all about the heart telling the eye to tell the finger to press the shutter release, and that's something you cannot teach anybody, it must be inside you from the beginning."

*(Left above) This was shot on Gullane Beach near Edinburgh. The model was a young French girl who came to the Yerbury's exhibition and asked if she could model for them.*

28-200mm lens, Kodak T-MAX 100, 1/60th sec, f2.8

*(Left below) The lower left shot was taken in a ruined church near the center of Edinburgh. Only the outer contour of the shape of the model's body is out of shadow, the circularity of her breast is echoed in the roundedness of her hip.*

150mm lens, Kodak T-MAX 100, 1/30th sec, f2.8

*(Below) Shot in a hotel suite, the sumptuous rich colors of the surroundings are brought out by tungsten lighting.*

45mm lens, Kodak T-MAX 100, 1/60th sec, f2.8



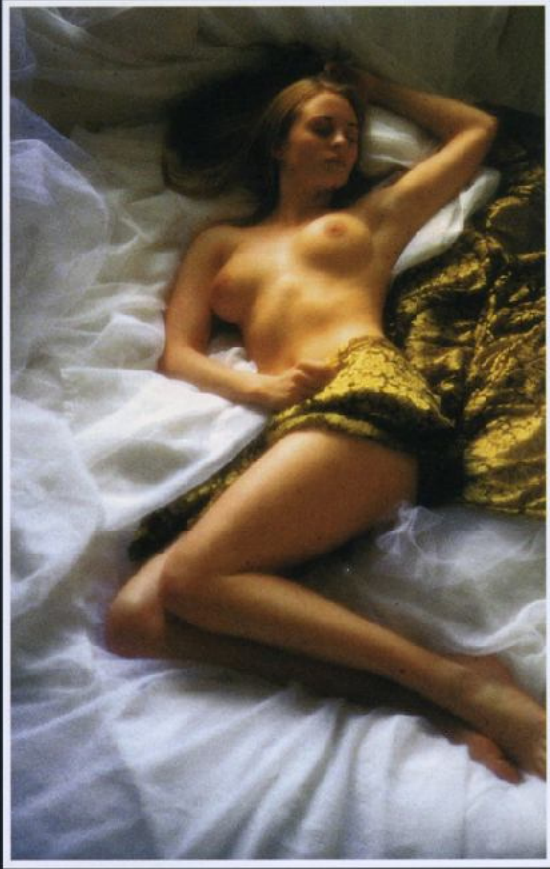

*(above) Shot in the early evening in one of Scotland's most romantic castles, this will hopefully be published as a part of Victoria's Summer, a series of photographs and diary extracts taken from the summer of 2002.*

28mm lens, Kodak T-MAX 100, 1/30th sec, f2.8

*(right) This was shot on a late summer evening, and was the subject's first experience at modeling.*

28-800mm lens on TCN400, Kodak T-MAX 100, 1/60th sec, f2.8



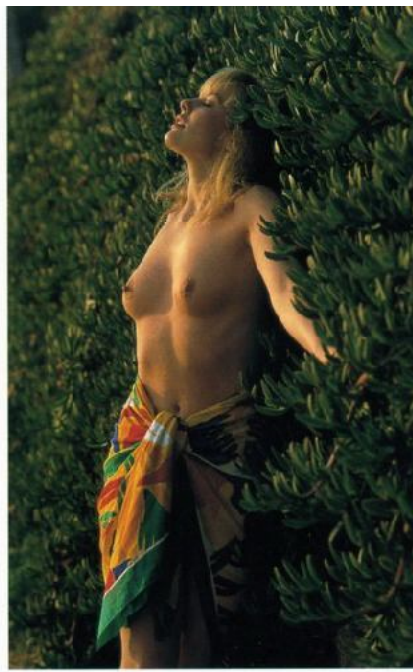

## SECTION TWO

# **WORKING PROFESSIONALLY**

### **80 INTRODUCTION**

\*Choosing a theme \*Studio or location \*Choosing your model

### **88 PHOTOGRAPHIC EQUIPMENT: CAMERAS**

\*Medium- and large-format cameras \*Digital cameras

### **92 PHOTOGRAPHIC EQUIPMENT: LENSES**

\*Fixed focal-length lenses \*Zoom lenses

### **96 PHOTOGRAPHIC EQUIPMENT: FILM**

### **98 PHOTOGRAPHIC EQUIPMENT: ACCESSORIES**

\*Motor drives \*Tripods \*Remote releases \*Meters \*Flash \*Filters

### **108 LIGHTING CONDITIONS**

\*Early morning light \*Evening light \*Direct overhead sunlight \*Diffusion \*Shooting into the sun \*Flare  
\*Reflectors \*Natural light indoors \*Artificial lighting \*Electronic flash \*Tungsten lighting \*Mixed light sources \*Fill-in flash

### **124 SHOOTING IN A STUDIO**

### **128 SHOOTING ON LOCATION**

\*Outdoor locations \*Interior locations \*Improvized locations

### **138 COMPOSITION**

\*Composing the image \*Viewpoint \*Backgrounds and foregrounds \*Using locations \*Clothes and props \*Abstract shapes

### **148 THE MODEL**

\*Model/photographer relationship \*Assessing a model \*Posing

### **156 POST PRODUCTION**

\*Digital correction \*Presentation





# INTRODUCTION

It is often said that there are no rules in glamour photography, which suggests, quite correctly, that great glamour photography relies on originality and innovation. This may be a good motto for the aspiring photographer, but as a piece of advice it is misleading. There are rules that can be learnt and applied, helping the amateur photographer to get over the first hurdles, and before very long he or she will be producing competent pictures. However, competence is small comfort to the ambitious photographer. The desire to do better and more imaginative work leads the photographer to leave behind the standard approach to glamour photography and achieve effects that would not be feasible if all the conventional rules of photographic technique were followed rigidly. Rules can, after all, be broken successfully but it helps to be familiar with them in the first place.

You will find that some of the following captions do not feature shutter speed details. This is because professional photographers tend to leave the shutter speed out of their calculations when exposing pictures by studio flash with a leaf shutter camera. The reason for this is that leaf shutter cameras can be synchronized with the flash at any speed: it therefore makes sense to work by aperture size alone.

## CHOOSING A THEME

The first rule of glamour photography is "do not touch the camera until you know precisely what you want to achieve." You must find a starting point. It can be anything—a particular location, a particular prop, a clever lighting trick, or even a simple composition that would benefit from the inclusion of a model. The photographer in charge of producing a tire firm's calendar spotted a shop selling oversized objects like typewriters and cameras, all made from felt stuffed with paper. The ordinariness of the objects contrasted strongly with their outlandish size and texture, and the photographer decided to make them the basis of the calendar. The resulting pictures, in which models posed nude with the soft sculptures, were all thematically linked and the series worked well together.

On another occasion a photographer was commissioned to shoot a series of pictures for a company that made corrugated aluminum sheeting—not the most promising material to work with. By using clever lighting, the photographer was able to bring out the strong linear texture of the sheeting and used it to form graphically dynamic backdrops for his models.

Each scenario you think up must be related to the others and yet

*Even in the confines of the studio, it is important to visualize the overall effect before picking up the camera. This head and shoulders shot uses one main light and two reflectors to fill in the sides, ensuring completely even lighting all around the model's face.*

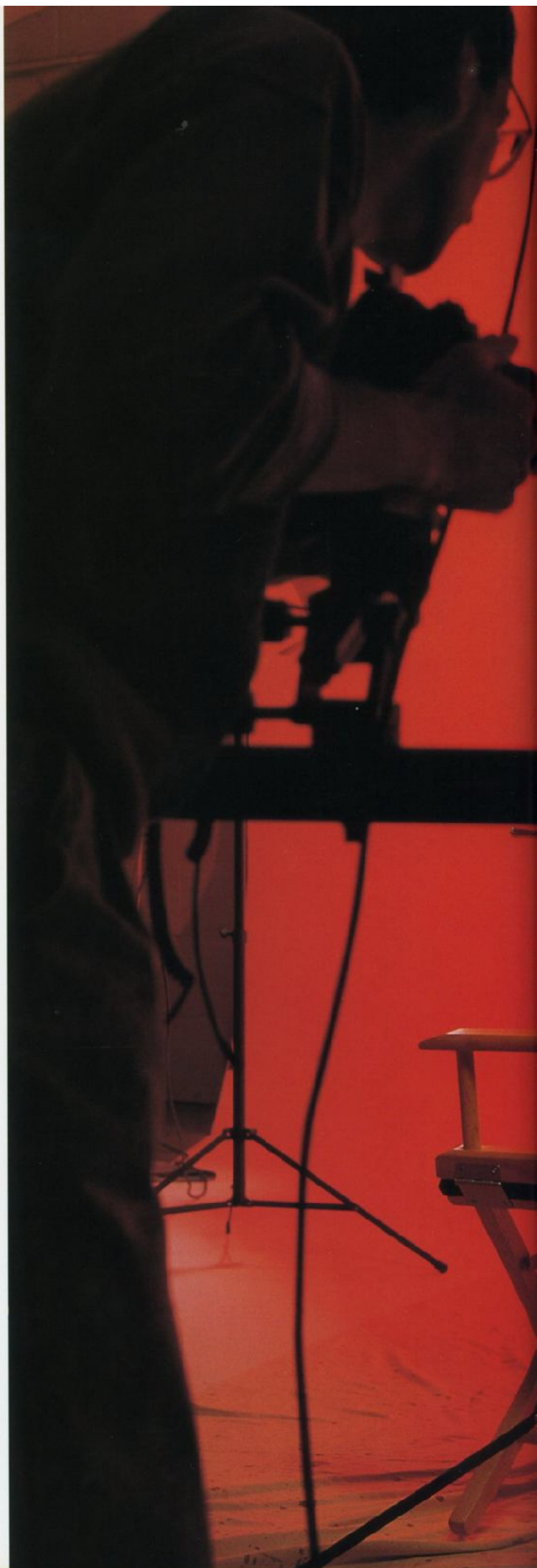



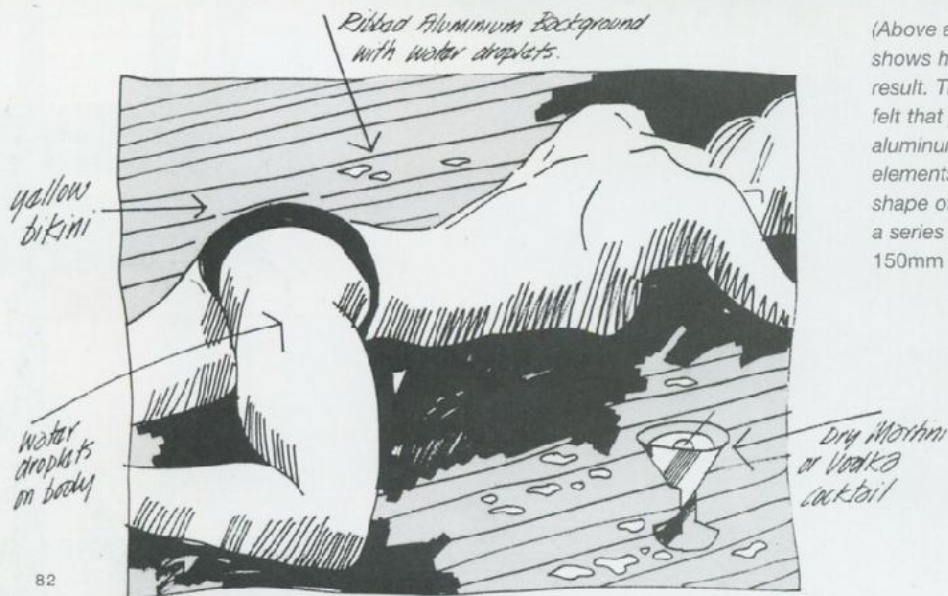

(Above and left) The original rough for the picture above shows how the shot altered between conception and the final result. The color of the bikini was changed, because the client felt that yellow would not stand out strongly enough for the aluminum background. However the essential design elements of the picture—the position of the model's body and shape of the glass—remained the same. The shot was part of a series taken to advertise corrugated aluminum sheeting. 150mm lens, Ektachrome 64, 1/125th sec, f16

each one must stand up as a strong image in its own right. Let us suppose your starting point is a brightly colored deck chair. An idea of the shot builds up in your mind. A nude model sits in the deck chair with a straw hat pulled down over her face. The band around the model's hat matches the stripes of the deck chair.

For the second shot you might choose a white-painted wrought-iron chair such as one finds in the gardens of English country houses. A model wearing a

transparent veil-like white blouse sits in the chair. She is also wearing a wide-brimmed Edwardian hat, and you choose a camera angle that shows her figure but not her face.

Immediately there are similarities between the two images—both models are sitting on chairs, both faces are hidden by hats. Equally, there are dissimilarities. The chairs, hats, and locations are all different. The pictures are related but they can stand separately. You are on a theme.



*(Above and left) Within the overall theme and style of the shoot, have an idea of the different type of poses that the model can easily run through. The picture to the left uses the sun to provide rim lighting of the subject. 150mm lens, Ektachrome 64, 1/125th sec, f5.6*

### LOCATION SHOOTING

*On location in Sweden, the photographer and his assistant spent much of the short day building and setting up the three silver columns so that they would be in the correct position in the frame when the time came to photograph the models.*

*Low evening sunlight threw a soft light across the scene, but the photographer had to work swiftly in order to finish the shot before the light levels dropped completely. The temperature also dropped fast, which explains why the photographer's gloves can be seen lying on a foreground rock. The models had to suffer for this particular picture.*

However, don't rush out and hire your model just yet. All you have are the beginnings of an idea. As you dream up more variations you may find that one of your elements will work against you, the hidden face possibly. If you decide not to use that particular aspect, you will have to rethink all the pictures, and any professional photographer will tell you that change is always against lax thinking. It forces you to pay attention to detail, allows you to conceive the composition of the picture, and helps you to plan your lighting and to choose which lens you need.

Professionals rely heavily on roughs because they can save so much time in the shooting if everyone involved knows what the end result is intended to look like. Time, to a professional, is money; an extra five minutes spent in the planning stage can save you a day of shooting.

Once you have drawn up the roughs, you are ready to start assembling the various elements that will make up the final pictures. But first a multitude of questions must be answered. How many models will you need? Where will you find them? Where will the pictures be shot? What equipment will you need? The answer to each of these

questions will provoke more questions, and it is only when you have solved all the problems that you will be ready to shoot.

### STUDIO OR LOCATION

The first thing to decide is where you want to shoot the pictures. You have the choice of a studio or a location. Your original idea may dictate which you use, but if

there is a choice then there are certain conditions that you should bear in mind.

The use of a studio allows the photographer to control all the elements, such as varying the quality or intensity of the light at will; making sure the model does not suffer from goose bumps by turning up the heating; preventing air currents from moving the model's hair during long

exposures; and shooting at any time of the day or night. You can limit the number of people on the set and it should be relatively easy to find adequate changing and make-up facilities. Also sets can be built that precisely suit the requirements of the picture.

Location shooting has merits that may outweigh the relative comfort of a studio; the first and foremost of these is authenticity.

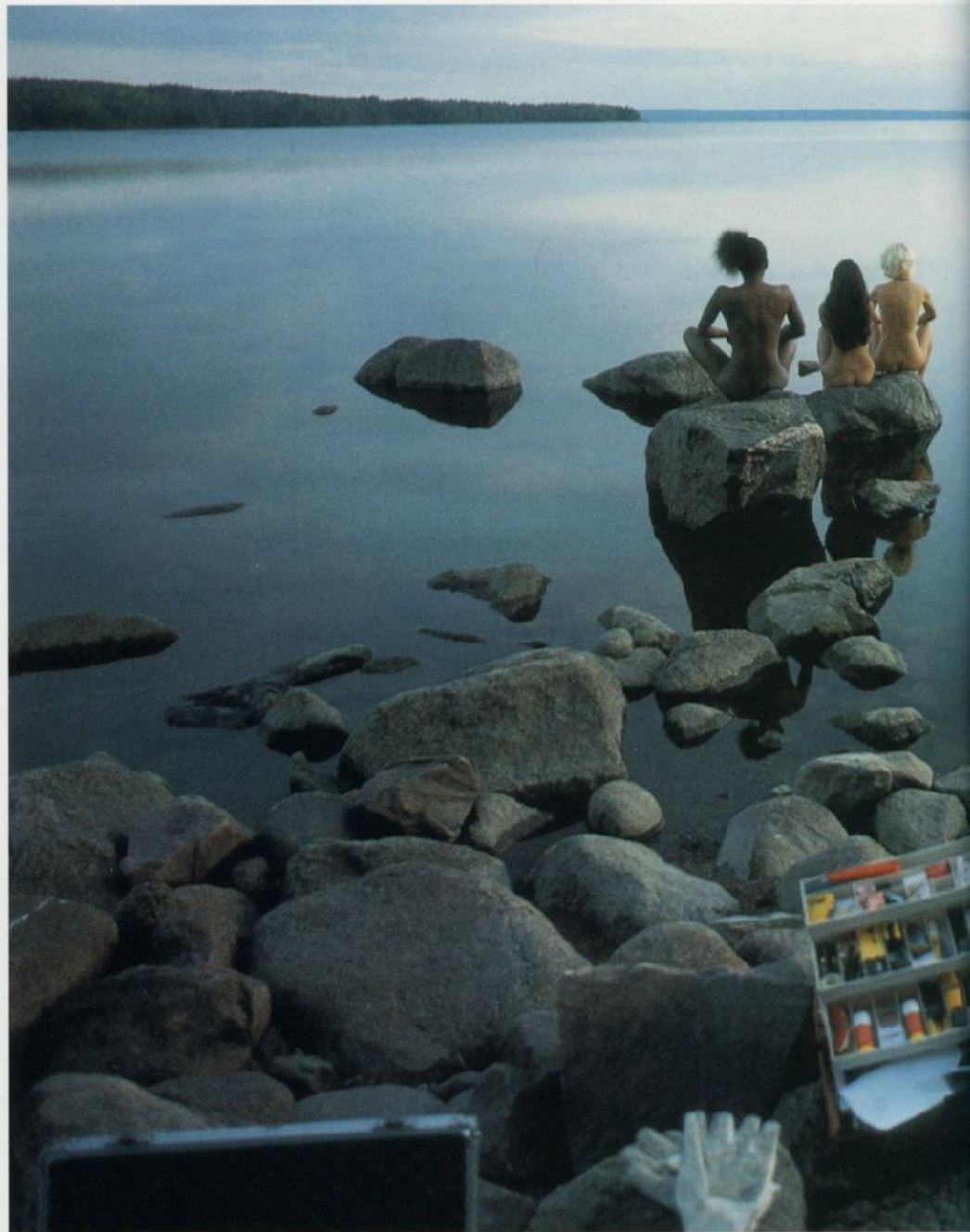

## EQUIPMENT CHECKLIST

Camera(s)	Three Nikon bodies
Lenses	28mm-45mm zoom, 85mm, 70mm-210mm zoom, 50-300mm zoom
Film	125 rolls of Fujifilm Provia 125 rolls of Kodachrome 64
Lighting	Four tungsten lamps with stands, six 120-watt bulbs, six 220-watt bulbs, gold fabric for reflectors, hand mirror, handheld flash gun, batteries
Camera accessories	Two tripods, filters (star, graduated, and polarizing) cable releases, metal camera case, refrigerated bag for film, shoulder bag, powerwind, camera-cleaning equipment, stepladder

## SHOOTING DAY CHECKLIST

Location	Plage des Oiseaux, Marin, France
Transport	Ford Galaxy (Red)
Meeting place	Hotel Splendide, Nice
Catering	Picnic lunch supplied by C.B. (agent)
Model	Lucy Charm Booked: 7.30 hrs to 18.30 hrs
Clothes	Model's own clothes and red scarf, yellow bikini top (supplied by photographer)
Props	Sunglasses, red airbed
Makeup	Model's own makeup
Assistants	F.M. (camera assistant)

Pictures taken by studio light against artificial backgrounds look unnatural. Try building a moonlit Jamaican beach in a studio and photographing the result. However hard you try, the real thing will always look better.

There is another, less easily quantifiable, but very real advantage to location shooting. You are far more likely to derive flashes of inspiration when you

are outdoors in natural surroundings than in the bland confines of a studio. The way a certain tree leans may form a perfect backdrop for a particular shot. Light filtered through overhanging boughs usually looks better than light filtered through a Vaseline-smear lens or added as an afterthought in Photoshop. So, before deciding where to take your pictures, assess the pros and cons of

studios and locations and make your plans accordingly.

## CHOOSING YOUR MODEL

The next consideration is the model. You have three alternatives—amateur, semi-pro (freelance), or professional (agency) models. Your choice will depend largely on your budget. A well-known agency model can

## CHECKLISTS

Efficient planning and organization are essential if you want a shooting session to run smoothly. This means attending to a mass of detail. A checklist of photographic equipment, and another itemizing everything that needs to be assembled, and listing the schedule of the shoot, can save a great deal of time and worry on the actual day.

cost as much as \$225 an hour and celebrity models are astronomically expensive, but for that amount you will have hired a girl who knows exactly how to achieve the poses and looks that you want. A good model will give you the desired effect and will understand the need to work quickly and efficiently. She will turn up on time, ready and willing to follow your instructions to the letter. The big difference between an agency and a freelance model is that you are guaranteed a physically flawless model from the agency whereas the freelance model might have some imperfection that is not readily apparent at first sight.

Model agencies are available in all the big cities and are usually listed in the telephone book or on the internet. However, bear in mind that the cost of any model booked through an agency will have an agency fee of around 10–20 percent.

The freelance model, thanks to the internet, has largely replaced the need for amateur models. The semi-pro does not usually belong to an agency but will either have her own website, or have a listing on one dedicated to models. *One Model Place* ([www.onemodelplace.com](http://www.onemodelplace.com)) has an excellent resource of models in the US, UK, and around the world. The semi-pro model is cheaper than the agency model, and the skill and experience can range from rank beginner to very experienced. You will have to pay the semi-pro model on the day of the shoot and, while there is no agency fee to pay, you are expected to cover traveling costs. The big advantage of the semi-pro model is that there are plenty of them around the country. Also, you can check out sample pictures and see their rates before you make contact. Many model or photography websites now have message boards so you can advertise the job you have and the rates you



will pay and then wait for the models to come to you. The site at *Photography World* ([www.photographyworld.co.uk](http://www.photographyworld.co.uk)) is particularly useful for this.

Because of the advent of the freelance or semi-pro model, it is more difficult to find amateur models. If a girl is interested in modeling she is probably doing so already. One way is to ask a female friend whether she would like to model for you. Another way is to approach a girl who you think looks promising. It is quite likely that your motives will be misunderstood so this should be done as tactfully and professionally as possible. You can explain to the girl who you are and what you do, and tell her that you think she has the potential to be a good model. It may help to have some cards printed, giving your name, address, and telephone number. If possible, have one of your pictures printed on the card. When you hand her the card, ask her to contact you if she is interested. This will enable her to decide in her own time, under no pressure, whether or not to take up your offer. If she does contact you, arrange to meet on neutral territory and perhaps suggest she bring a friend with her. You can then explain more fully what you have in mind. There are some top professionals who specifically like to use amateur models so that they can get a very fresh and unposed look.

If the girl has a talent for modeling and is interested in starting a career, you should do your best to help her. Give advice on how to put a portfolio of pictures together and help her to get in touch with the right people. Explain the pitfalls that exist in the modeling world and tell her about model-release forms, which assign the photographer the right to use pictures as specified on the form.

In all instances you should ascertain what type of modeling your prospective model will undertake before approaching her. When discussing your requirements, fully explain what you have in mind and where the shoot will take place. If it is to be a location shoot, the model may wish to bring a chaperone along.

If your photos are for publication then you should ensure that the model-release form is signed. Make sure this is explained beforehand because almost all models will charge extra if they know that it is for publication. It may be an extra 20 percent, or more commonly, the equivalent of one to two hours extra shooting. The model-release form should state that the model guarantees she is over 18 years of age and in addition, that she assigns all rights to pictures to the photographer.



### TEST SHOTS

*In these pictures (above and right) a professional model is going through a routine so that the photographer can take a series of photographs showing her figure from various angles. The model's facial expressions are also important as they give a clear impression of the range of "looks" the girl is capable of. The resulting photographs will be used by the photographer as test shots, to enable him to assess the model's suitability for an assignment; sometimes the photographer may give the model a selection of test shots for her own portfolio.*  
44–112mm lens, Fuji S1 Pro digital, ISO 160, f2.8



**STANDARD FORM FOR SIGNATURE BY MODELS**

Issued by the INSTITUTE OF INCORPORATED PHOTOGRAPHERS and the INSTITUTE OF PRACTITIONERS IN ADVERTISING

Name of photographer \_\_\_\_\_ Negative series No. \_\_\_\_\_  
 Name of \*Advertising Agency/Client \_\_\_\_\_ Order No. \_\_\_\_\_  
 Product of service \_\_\_\_\_ Date of sitting \_\_\_\_\_

In consideration of the sum of \$ \_\_\_\_\_ and any other sums which may become due to me in accordance with the Terms For Employment of Professional Models from time to time agreed between The Institute of Practitioners in Advertising and the Institute of Incorporated Photographers, which shall be paid to me (or my agent) for posing for the photographer(s) referred to above.

I permit \_\_\_\_\_ and its licensees or assignees to use the photograph(s) and/or drawings therefrom and any other reproductions or adaptations thereof either complete or in part, alone or in conjunction with any working and/or drawings for all advertising and/or publicity and/or editorial purposes in connection with the above product or service in the United Kingdom and/or country(ies) overseas.

Unless otherwise agreed the photograph(s) and any drawings or adaptations thereof shall be deemed to represent an imaginary person. I understand that I do not own the copyright of the photograph(s). (\*delete as applicable)

\* I am over 18 years of age.

\* I am not over 18 years of age but my parent/guardian has agreed to my undertaking this work and the use of my photograph(s) as mentioned above.

Name (in caps) \_\_\_\_\_  
 Signature \_\_\_\_\_  
 Address \_\_\_\_\_  
 Date \_\_\_\_\_  
 Witness \_\_\_\_\_

This form must be signed by the model, witnessed, and a copy delivered to the advertising agency/client with the photograph(s).

© Institute of Incorporated Photographers 2003  
 Institute of Practitioners in Advertising



**MODEL-RELEASE FORMS**

*It is important to establish a clear arrangement with your model. Misunderstandings are more likely to arise with an amateur model who is not protected by an agency and is unclear about her rights. Explain to the model about model-release forms (above). Once the model has signed, the photographer has permission to use the pictures as specified on the form.*



# PHOTOGRAPHIC EQUIPMENT: CAMERAS

The 35mm SLR (Single Lens Reflex) camera is most suitable for glamour photography, particularly for location work. It is light, relatively cheap to buy, and also cheap to run in terms of the number of images per roll of film. Despite the low price, it is a sophisticated piece of equipment—well engineered and capable of standing up to wear and tear.

Modern 35mm SLRs offer the photographer complete control of his exposures. A built-in light meter suggests what settings should be made on the aperture and shutter dials. The photographer can either use these or choose his own, according to how he wants to vary the image.

Cameras of this kind are often provided with automatic exposure controls, which ensure that the photograph is correctly exposed. This enables the photographer to concentrate on watching the action and pressing the shutter release at precisely the right moment.

A wide range of shutter speeds is available, typically from 1 second to 1/1,000th of a second. The fastest speed will "freeze" most fast-moving subjects, including racing cars, falling rain, and running water. Mid-range speeds—1/250th sec, 1/125th sec, and 1/60th sec—are the most commonly used in glamour photography, where the subject is relatively static. At these speeds the photographer can hand-hold the camera without fear of camera-shake. These speeds also allow the use of a wide range of aperture settings, giving the photographer scope to increase or decrease the band of sharp focus (depth of field) in the picture at will.



## 35MM CAMERA

*For ease of use in the studio or on location, the 35mm SLR is the most suitable and practical camera type.*

At speeds below 1/30th sec, camera support must be used to prevent camera-shake. A sturdy tripod is the surest solution to this problem. Slower shutter speeds are useful because they allow moving elements in the image to blur, while anything stationary remains sharp.

The 35mm frame is big enough to allow good print reproduction and small enough to allow the photographer to load up a 36-exposure cassette. The 35mm film format offers the greatest range of film choice—everything from infrared black and white, through to negative and reversal films up to 1,000 ISO. (ISO stands for International Standardization Organization—the most common rating system for film in English-speaking countries.)

## MEDIUM- AND LARGE-FORMAT CAMERAS

For sheer versatility 35mm must be the glamour photographer's first choice, but quality of reproduction is also important, particularly among professionals who earn a living by selling their



## MEDIUM-FORMAT CAMERA

*The Mamiya RZ67 Pro II is the standard medium-format camera for professional studio work and features the ideal negative or transparency size.*

pictures to magazines or calendar companies. The larger the original negative or transparency, the better chance the printer has of ensuring perfect reproduction, and this is the reason why the 6 x 7cm and the square 6 x 6cm formats are firm favorites.

By opting for 6 x 7cm, the photographer commits himself to using a far bigger camera, and

the prices of these machines are up to three times more expensive. There is just as wide a choice of lenses available as there is for 35mm, but again costs are much higher. The medium-format cameras are better for studio work than for location shooting. They have interchangeable film magazines so that the film can be changed in one while the photographer is shooting on another.



*Rectangular film formats, such as 35mm, 6 x 7cm and 6 x 4.5cm, offer definite advantages over the square frame produced by 2 1/4 sq in cameras. In this picture the photographer has echoed the upright stance of the model by turning the camera on its side. The inclusion of the pillars on either side of the model hold the frame together, and help to give the whole shot a feeling of vertical strength.*

50mm lens, Kodachrome 25, 1/125th sec, f8

Another point in their favor is the availability of Polaroid backs. These can be clipped to the back of the camera and instant prints can be obtained of the shot. The professional uses the Polaroid shots to assess color balance and lighting before shooting the picture on conventional film. In this way, errors can be spotted and eliminated.

While some cameras are bulky and specifically designed for use in a studio environment, if the point and shoot flexibility of the

35mm SLR is required then there are now a number of models that simply look like larger versions of ordinary 35mm cameras. These are often in the 6 x 4.5cm format that offers 2.7 times more picture detail than 35mm but gives 15 shots on 120-roll film. Some 20 years ago the 6 x 6cm format was predominant in the medium-format market but this is no longer the case. While it is true that a 6 x 6cm landscape photo would have to be cropped to fit a rectangular book or magazine page, and thus run the risk of

losing vital detail, the clever glamour photographer will have ensured that the model is central with nothing vital at the edges of the shot. It is now more likely that the glamour photographer using medium format will use 6 x 7cm for pure quality or 6 x 4.5cm for a lighter camera.

Film choice is no longer a problem either since Fuji provides a wide range of 120-roll film for all occasions and uses. Kodak emulsions are also still popular. Above that, there are view

cameras which offer 12 x 9cm or even 24 x 20cm frames. These cannot be handheld and are phenomenally expensive. They are really the preserve of the professional and, in knowledgeable hands, they can produce absolutely stunning results. These type of cameras are really only used for very specialized shoots and are seen more in landscape photography where the extra detail is better appreciated.

There is no need to invest thousands of pounds in a medium- or large-format camera, if you simply intend to shoot glamour pictures. The 35mm SLR will suit your needs adequately.

## **DIGITAL CAMERAS**

The digital camera market is advancing at a tremendous rate and in just three years the leading consumer cameras have tripled their resolution. This is as if your 35mm camera had been



(Left) The square format is finding favor once more, but where the image is to be reproduced on the page, the photographer needs to consider whether it can be cropped into a rectangular shape. 50mm lens, Kodachrome 25, 1/64th sec, f5.6

(Right) The horizontal rectangular frame suits the shape of the prone model, and allows the photographer to capitalize on the horizontal bands of water behind her. The strength of the shot lies in the directional consistency. 50mm lens, Kodachrome 64, 1/125th sec, f6.6

upgraded to the quality of a 6 x 4.5cm camera without the price increasing. The advent of glamour content on the web means that shooting for such a market doesn't even require the latest technology. A 2Mp camera is fine if your photos are to grace web pages. However, to offer a qualitative equivalent of a 35mm SLR camera then the current crop of digital SLRs with interchangeable lenses will suit. The Canon D60 and Nikon D100 both offer a 6Mp true resolution that is the equivalent of 35mm film in terms of detail, if not quite matching the quality that can be found from a slow slide film stock. Both cost around \$3,000, making them around four times more expensive than an equivalent film camera. The Fuji FinePix S2 features a special 6Mp SuperCCD chip that gives a 12Mp output, exceeding the detail found in 35mm, offering vibrant colors and excellent skin tones. Its predecessor, the under-specified S1, found favor amongst wedding and social photographers for its rendition

**RECTANGULAR FORMAT**

Most roll-film formats give rectangular pictures—6 x 4.5cm and 6 x 7cm. The advantage of these formats is that the shape of the final image is closer to that of magazine or book pages. Since this is where most of the shots are intended to be published, it helps both the photographer and the designer to avoid the problem of cropping.





of skin tones. At around \$4,000, the S2 would seem to be the perfect camera for the glamour photographer. There is also the Sigma SD9 camera to consider, which, though only offering a 3Mp resolution, uses a special color-sensitive chip that delivers three times the color accuracy of any other digital camera. Where color fidelity is more important than outright resolution, this is the ideal camera.

All of these digital SLRs use interchangeable lenses from existing film camera ranges making them an easy upgrade route from film. However, they all have a side effect. Because the CCD (Charged Coupled Device)—the electronic sensor that replaces film—is actually smaller than film, the effective focal length of the camera, in terms of field of view rather than perspective distortion or compression, is increased by around 1.5 times. Thus a 35mm lens will give a field of view that is comparable with that of a

52mm lens, but will suffer from more distortion than a genuine 52mm lens. If working in a very small environment it could prove to be problematic.

A full-frame digital camera is available from Contax, but here the price jumps to around \$9,000, therefore it may be worth considering the other route into digital. This is the digital back that fits onto a medium-format camera just like a film back. Instead of film it contains a CCD and generates high-resolution images that benefit from the use of super high-quality lenses. Companies such as Kodak are the leaders in this field and have introduced 12Mp resolution digital medium-format backs but the price soars to well over \$15,000. Professionals such as Patrick Lichfield are amongst those desiring to combine the outright quality of medium format with the immediacy and electronic usability that digital provides.

#### DIGITAL CAMERAS

The various digital SLRs that are now on the market match or exceed 35mm film, but not medium format. However, it is possible to buy very expensive digital backs that can be added to some medium-format cameras.

A Kodak Professional DCS Pro Back Plus is shown at the bottom of the page.



# PHOTOGRAPHIC EQUIPMENT: LENSES

The glamour photographer will also need a range of lenses for the camera. The 35mm camera accepts a wide variety of lenses that allow the photographer to vary the kind of shots he takes. Lenses with a focal length shorter than 35mm have a tendency to distort the image, which makes them largely unsuitable for this kind of work. The only exception is if you deliberately set out to produce a distorted shape, but generally glamour shots do not benefit from this.

## FIXED FOCAL-LENGTH LENSES

**35mm and 50mm lenses** allow you to include the background. The standard lens for a 35mm camera has a 50mm focal length and is said to cover an angle of view approximately similar to that of the human eye. With a 50mm lens it is possible to take a full-length picture of a person from about 9 ft (3m).

Both 35mm and 50mm lenses usually offer wide maximum apertures, f1.8 or f2, which makes them ideal for use in low light, or for differential focusing: this is a technique that allows you to select a critical band of sharp focus when operating at a wide aperture, leaving everything else a blur.

**85mm and 105mm lenses** are often used by glamour photographers. The design of these lenses is relatively simple and even budget-priced versions can produce sharp, rectilinear images. However, the real reason for their popularity lies in the distance from which the photographer can obtain a good close-up of the model. There is nothing more off-putting, even to the professional model, than having the lens about a foot



away from her face. A long-focus lens, such as the 85mm or 105mm, allows the photographer to stand far back while shooting close-ups. These lenses also offer fast maximum apertures.

**135mm lenses** can be useful, particularly on location where there is more space, and can essentially fulfil the same functions as the 85mm and 105mm long-focus lenses. With a 135mm lens you start to see the compression of perspective that is such a noticeable trait on a true telephoto lens such as a 200mm or 300mm. This effect can be pleasing but it must not be over-used. The glamour photographer will have little need for lenses longer than 200mm. If

## CHOOSING A LENS

Fixed focal-length lenses offer higher quality than zoom lenses but suffer from a lack of flexibility that a zoom can offer.



(Right) There is little need for the well-equipped photographer to actually move in relation to his subject, even if he wants to change the framing from wide angle to close-up. He can use a zoom lens that offers him a range of focal lengths, or he can use a set of fixed focal-length lenses. The quality of the fixed lenses



tends to be higher than that of zooms, but zooms are much more convenient, because the photographer does not have to physically remove the lens from the camera to change the framing. Examples of shots taken by zoom and fixed focal length lenses (right): 150mm setting on a 70-200mm zoom (1); 105mm fixed lens (2); 85mm on a 70-200mm zoom lens (3); 85mm fixed lens (4); 135mm on a 70-200mm zoom (5); 50mm fixed lens (6)



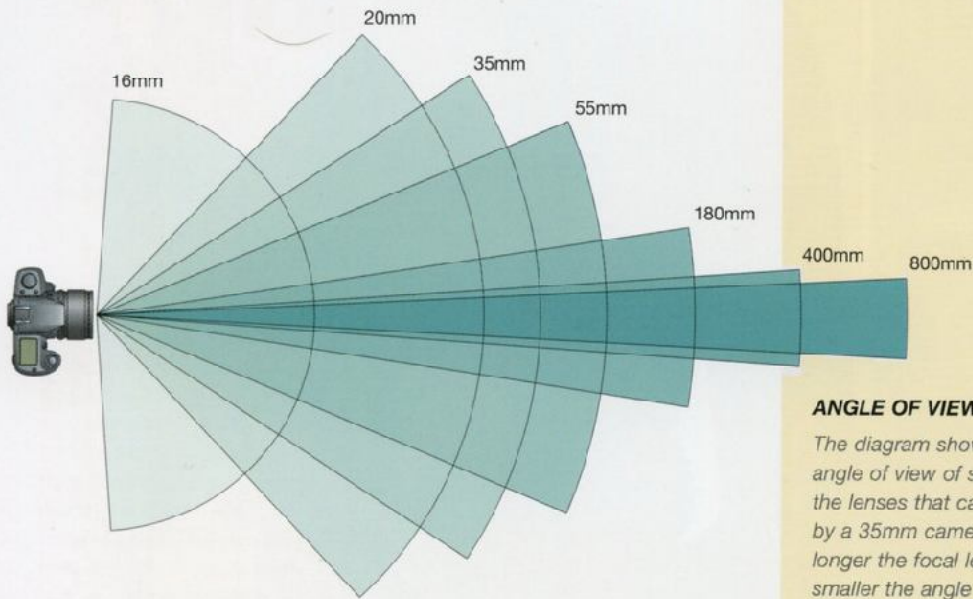

**ANGLE OF VIEW**

The diagram shows the angle of view of some of the lenses that can be used by a 35mm camera. The longer the focal length, the smaller the angle of view seen by the lens.

(Center) A 200mm lens demonstrates the compression of planes within a picture that is so characteristic of long telephoto lenses. In this picture, the heat haze rising off the Red Sea is emphasized by the use of a telephoto lens.

200mm lens, Kodachrome 25, 1/250th sec, f3.5

(Below) 50mm is the focal length of a standard lens on a 35mm camera. With a camera-to-subject distance of about 9 ft (3m) it is possible to include a standing figure within the frame, provided the format is vertical rather than horizontal. The photographer has taken this picture from about 6 ft (2m).

50mm lens, Kodachrome 25, 1/125th sec, f8

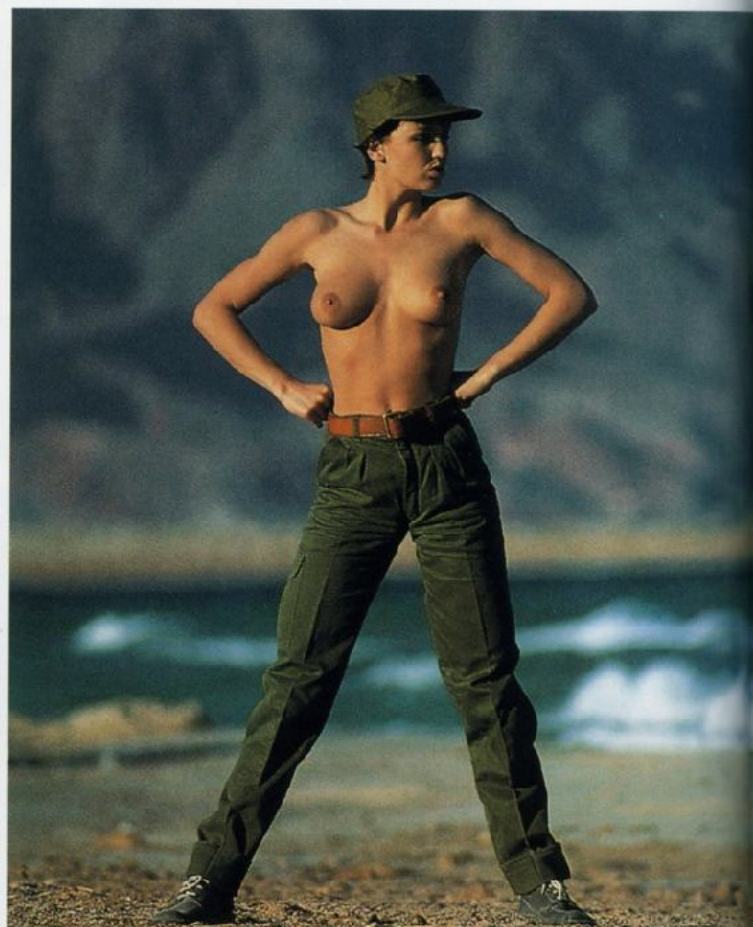

the working distance between the model and photographer becomes too great, communication between them becomes impossible.

**ZOOM LENSES**

The design of zoom lenses has changed dramatically over the last few years, and earlier criticism of them no longer applies, except in the case of very cheap units.

There are two varieties that the glamour photographer should at least investigate. The first is known as a mid-range zoom and typically has a focal length of 28-70mm. These lengths may vary by 5mm each way. This lens can do the job of both the 35mm wide-angle and the standard 50mm lens. The second zoom is the 70-210mm, which takes care

of the longer end of the focal scale. The large zoom that ranges up to 500mm is of no use in glamour photography. Increasingly common is the super-zoom that offers the entire zoom range from 28–210mm or even 35–300mm. If picture quality is the top consideration, avoid one of these because, although there is such a wide span of focal lengths, invariably you will lose out on quality.

The advantage of a zoom is that the photographer can alter the framing of the picture with one simple hand movement. With fixed focal-length lenses he needs to either change the lens or move his camera position until he finds the right position for the frame he wants. The main drawback of a zoom is that the maximum aperture is usually smaller than one would hope to

find on a fixed lens of the same focal length. The optical quality of a zoom is rarely quite as good as that of a fixed lens, but it would take a real purist to spot the difference these days, except on a super-zoom. Due to its popularity, the regular zoom lens has fallen in price and is now the mainstay of the 35mm market. Zooms for medium-format cameras are still very expensive.

*(Below) The principal advantage of using a wide-angle lens is that far more can be included in the frame than would be possible with a standard 50mm lens. Here, the photographer was able to include both the model as well as most of the swimming pool. The danger of wide-angle lenses is that proportions can become unattractively distorted. Here, the model's legs are considerably shorter than her arms.*

24mm lens, Kodachrome 64, 1/250th sec, f8

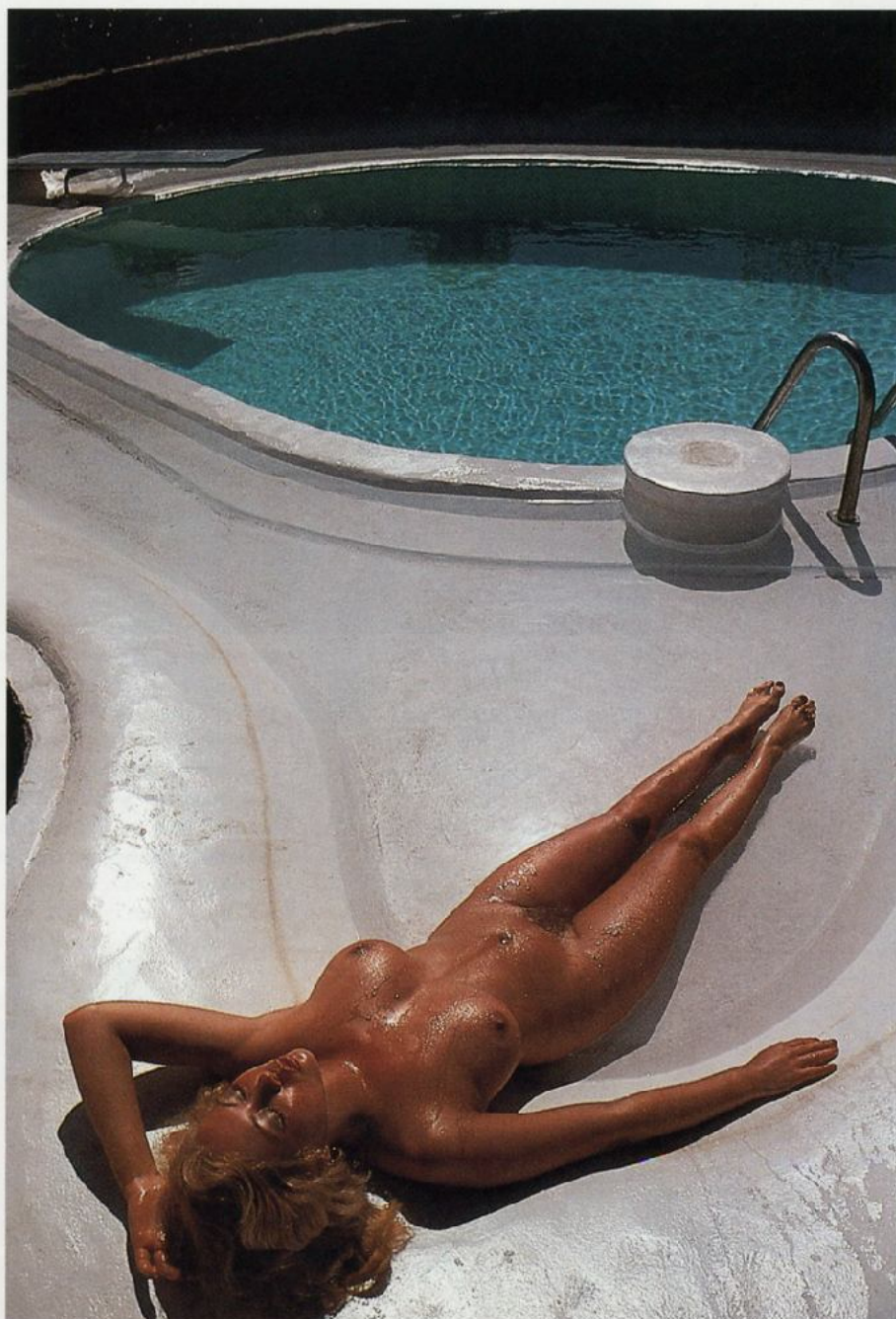



# PHOTOGRAPHIC EQUIPMENT: FILM

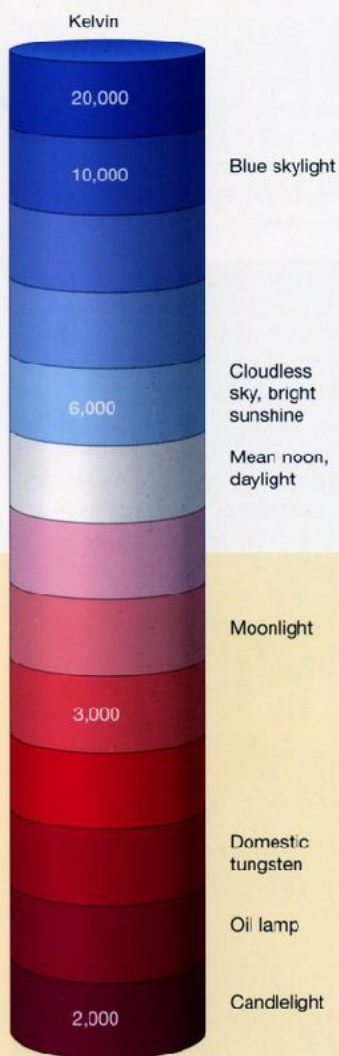

## COLOR TEMPERATURE

The color scale shows how different types of light give resulting color casts. Film is balanced for normal daylight conditions at 5,500K.

For color work, most professional glamour photographers prefer to use reversal slide film; their clients prefer it too. The main reason is that a transparency is the actual film on which the image was recorded. A print made from a negative is one step removed from the original, and it is therefore a less accurate reproduction of the image in front of the camera. In addition, a print can be made from a transparency more easily than a transparency can be made from a negative. While some picture libraries and desks will now accept digital media this is only currently really acceptable where the stock expected is 35mm. However, the quality of digital is constantly rising and it is only a matter of time before hi-resolution digital shot on 35mm digital cameras becomes the norm.

For 35mm film photography there's a choice of Fujifilm Provia with its clean, pure skin tones combined with exceptionally fine grain, or Kodak's Ektachrome 64 Pro, which gives super colors, pleasing skin tones, and increased sharpness. For medium-format, Fuji offers the Velvia brand, a favorite of landscape photographers thanks to its amazing color saturation; this should be considered for

location shoots. Some years ago the predominant film in the 35mm market was Kodachrome 25 but this has been discontinued. Today, the choice of the professional is Provia.

Both Kodachrome and Fujifilm films are balanced for daylight. In other words they are formulated to produce accurate color rendition in a color temperature of 5,500K the "color" of daylight. As a result they can only be used when the light source is daylight or electronic flash. If the source is tungsten illumination the results will be yellowish. This can be corrected by using a blue filter, but a far better solution, if you know you are going to shoot by tungsten light, is to use film that is formulated to accurately reproduce color at that color temperature (3,200K).

The problem with ISO 50 or 100 emulsions is that they are relatively slow. In dimmer light conditions it may therefore be necessary to shoot on faster stock with a rating of up to ISO 400. All film must be kept under stable, cool conditions if it is being stored for any length of time. Its high ISO rating enables you to shoot in lower light levels, although as a result, your pictures will have a grainy effect.

Black and white is less popular as a medium for glamour photography, but that has not prevented people like David Bailey from producing fine work. It is also prevalent in the artistic nude category rather than straightforward glamour. The distinctions between negative and reversal, daylight and tungsten, do not exist for black-and-white film. It merely has to be chosen according to its ISO rating. For digital users the creative choice is even easier. Everything is shot in color and selected shots can be turned into black and white on the computer at will.

As a general rule, and this applies to both color and black and white, the slower the film the finer the grain is. Unless your model has exceptionally fine skin it is unwise to use slow film for close-up work, because every blemish will reproduce accurately. Film rated at 125 ISO is probably the best all-round black-and-white film for glamour work, but faster films should not be overlooked. The slight blurring of detail that accompanies the use of 400 ISO film can appear on the print as a smooth finish, particularly suitable for glamour photographs.



## FILM

Fujifilm and Kodachrome are the two main brands of film for 35mm and 120-roll film.



*(Left) When shooting under tungsten lighting, a specialist tungsten-balanced film must be used to avoid a yellow cast on the photos. Digital cameras feature Automatic White Balance (AWB) control to rectify such casts. 50mm lens, Kodachrome 25, 1/125th sec, f8*

*(Below) A great deal of care must be taken both with film and lighting if the model is to be photographed from close-up, unless her skin is absolutely blemish-free. This picture, for example, shows up slight blemishes on the model's face. Slow film is finer-grained than its faster counterparts, and therefore reproduces any unevenness or mark with a clarity that can be dangerous. The grain found in faster films tends to blur such irregularities. 50mm lens, Ektachrome 64, 1/125th sec, f16*

Recent developments in black-and-white film technology have brought us variable speed films. These have a nominal rating of 400 ISO but can be shot at anything up to 3,200 ISO. The speed difference is taken care of automatically during processing. In use, these films have shown themselves to be particularly grain-free. In digital images, grain can be applied where required for artistic shots, or skin tones smoothed and blemishes removed for regular glamour. It is now common practice to digitally correct important or high-quality work for uses such as promotional material or calendars. Regular glamour for magazines is also subject to this but to a lesser degree.

If light conditions do not allow you to shoot at the aperture and shutter-speed settings you want, it is possible to uprate the film during processing. By prolonging development of a film that has been exposed at a higher speed rating than the manufacturer advises, you can redress the exposure balance. A good deal of detail in underexposed digital images can be brought back, but there is much less scope for saving anything that is overexposed.

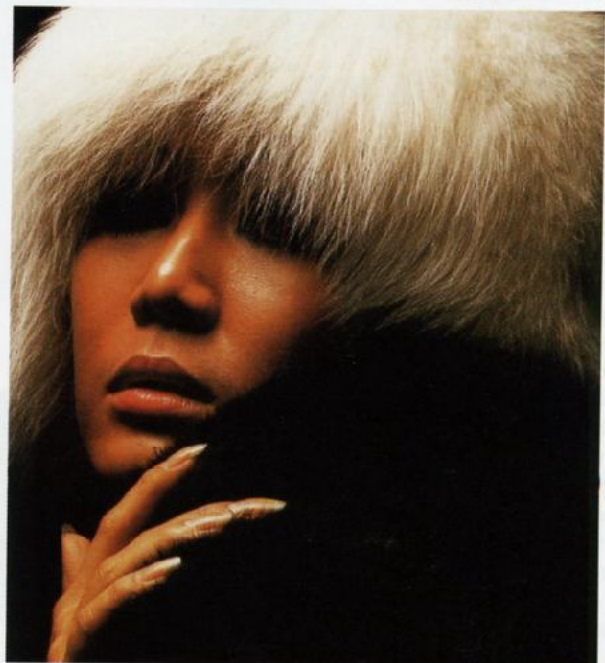

# PHOTOGRAPHIC EQUIPMENT: ACCESSORIES

Camera, film, lens, and light are the only essential requirements for any kind of photography. However, the photographer's desire to overcome specific restrictions has led to a growth in accessories. The most obvious example is the flashgun. This portable, controllable instant light source enables pictures to be taken in low light levels.

The glamour photographer has little need of accessories. Most of his work is carried out in bright light conditions. Unlike the sports photographer who must capture one split-second of action, the glamour photographer can easily work without a ten-frame-per-second motor drive and does not need to use slow shutter speeds that demand the use of a tripod.

However, most professional glamour photographers do use a variety of accessories, not through necessity, but because they know that at any moment the extra scope provided by an accessory may prove to be the difference between a good picture and a classic one.

## MOTOR DRIVES

A motor drive is particularly useful if you want to photograph a model performing some kind of action. If there is only time to take one picture during the course of the action the model will have to repeat it many times over. She will get tired and you will get frustrated. A motor drive, allowing you to fire off five or even ten frames a second, will vastly increase your chances of catching the model at the right moment against the right background, with the right expression on her face. The increased amount of film you will get through is a small price to pay under these circumstances.



### BUILT-IN MOTOR DRIVE

*Professional 35mm cameras tend to feature fast film-advancing motors that can help capture the action. Digital cameras have a burst mode but are limited by their internal memory.*

### ADD-ON MOTOR DRIVE

*Add-on motor drives are available for all formats of camera, but are prevalent in the medium-format field where fast-shooting is not usually part of the basic kit.*

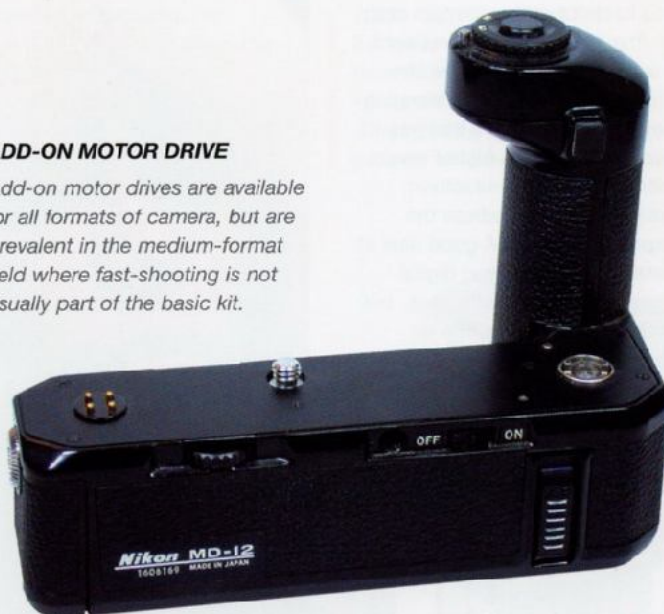

One technical point on motor drives: your shooting rate will be seriously impaired unless you can get a shutter speed above 1/60th sec. The time it takes for the camera to recock its shutter and lift up the mirror, added to the exposure time, will reduce the number of frames you can expose per second.

Most motor drives have both continuous and single settings. In the first case, the camera will keep firing until either the photographer takes his finger off the shutter release, or the film runs out. In the second case, only a single shot will be taken but the camera will wind on automatically. The nature of the shot will dictate which mode is more acceptable, but as a general rule the continuous setting should be used if the action is either very fast or very demanding on the model. The single setting is more suitable for sequences in which the success of the shot depends upon the photographer's ability to react quickly to a single, specific instance. On digital cameras there is a facility called the burst mode which enables a rapid sequence of shots to be fired in one second. The problem is that these shots go straight into the camera's memory buffer and once it is full, it then has to start writing the images to the memory card. Essentially you have to stop shooting until the internal memory becomes clear again. If shooting at high resolution this can be five seconds or more.

## TRIPODS

Without a tripod the photographer is denying himself the use of over half of his camera's shutter-speed range. This is simply because most people cannot hand-hold a camera with a

**CONTINUOUS SHOOTING**

*(Left) Sessions in which the model goes through a continuous sequence of poses are best captured by means of a power (auto) winder set on its "single frame" mode. Every time the photographer takes his finger off the shutter-release button, the power winder transports the film so that the next frame is ready for exposure.*  
 50mm lens, Kodachrome 100, 1/125th sec, f2.8

*(Below) To make the most of an action session, a motor drive is useful. The photographer simply keeps his finger on the shutter-release button. After each exposure the film is automatically wound on and the shutter trips as soon as the next frame is lined up. This way, the photographer is likely to capture a certain spontaneity and it saves the model having to repeat an action continually. The only risk is that film is exposed very quickly. In some cases, a 36-exposure roll of film coupled with a motor drive will travel through the camera in only seven seconds.*  
 80mm lens, Kodachrome 64, 1/64th sec, f16

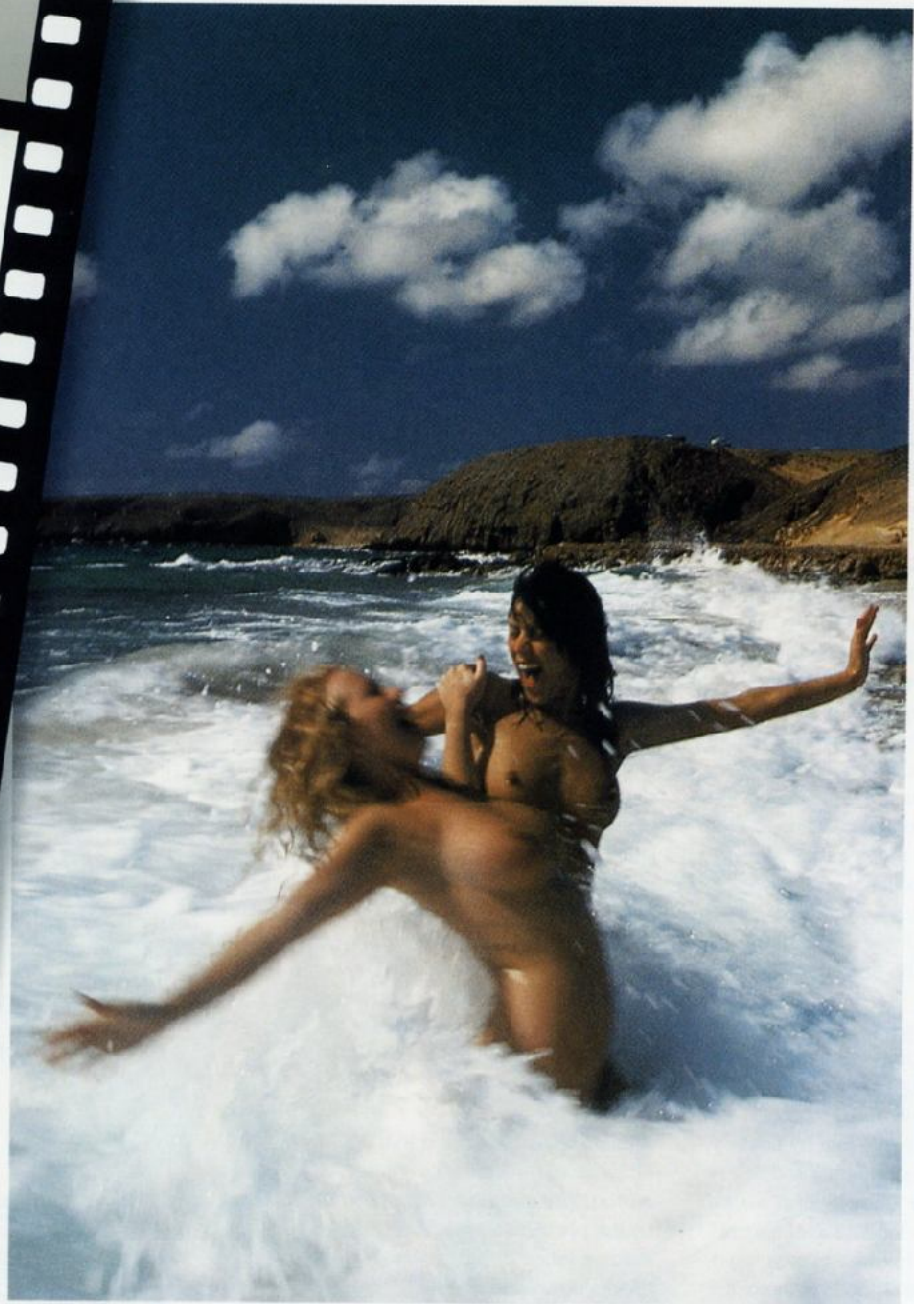

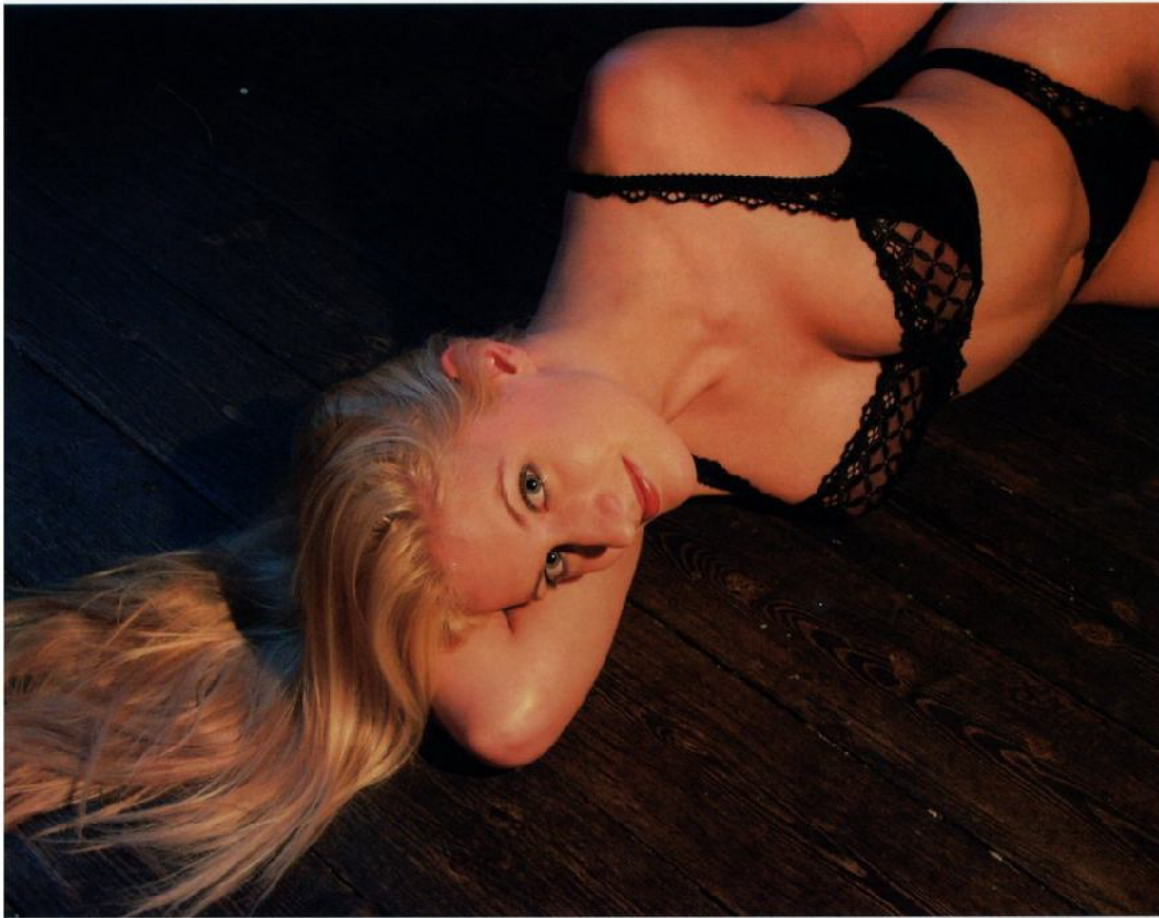

(Left) In low light conditions, a tripod must be used to avoid camera shake.  
Olympus E-20P, 1/8th sec, f2

50mm lens below 1/60th sec without inducing camera shake. The figure of 1/60th sec applies only when a 50mm lens is in use. The longer the focal length of the lens the higher the minimum acceptable shutter speed. As a rough guide, you can say that the minimum shutter speed necessary for sharp handheld pictures is the nearest in numerical value to the focal length of the lens. If, for example, you were using a 200mm lens you would not be able to handhold the camera below 1/250th sec.

There is little point in using a flimsy tripod. It might allow you an extra couple of stops of shutter speed, but you could probably achieve that by holding the camera very firmly and bracing your body against a wall. It is worth spending a little extra on a tripod to make sure you get a sturdy one. Tripods with spirit

levels on the horizontal and vertical planes will ensure that the camera is accurately lined up.

### REMOTE RELEASES

The normal pressure of a finger on the shutter-release button tends to move the camera slightly during exposure. At higher shutter speeds this makes little difference, provided that you squeeze the release gently rather than applying sudden sharp pressure. But at slow speeds the tendency is exaggerated, and can ruin shots even when you are using a tripod. The solution to this problem lies in the cable or air release.

A cable release is a cord that attaches to the camera's shutter button. When pressure is applied by the photographer, a wire inside a fabric or plastic sleeve moves down and transfers





**TRIPODS**

A tripod is an essential piece of equipment for a glamour photographer. Choose one of good quality, light enough to be portable, but solid enough to hold the camera and lens rigid. The standard tripod (far left) has extendable telescoping legs and a rising center column. For low viewpoints the column of some tripods can be reversed so that the camera can be mounted upside-down (left). A horizontal arm provides easy access to the camera's controls.



**TRIPOD FEET**

Tripod "feet" vary. Rubber or plastic compounds are most efficient for indoor use (far left). Some tripods have ribbed "soles" to prevent them from slipping on a smooth floor (middle). A spike gives a good grip for outdoor use (left).

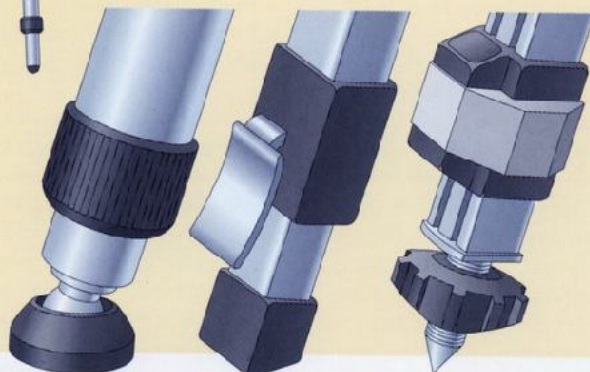

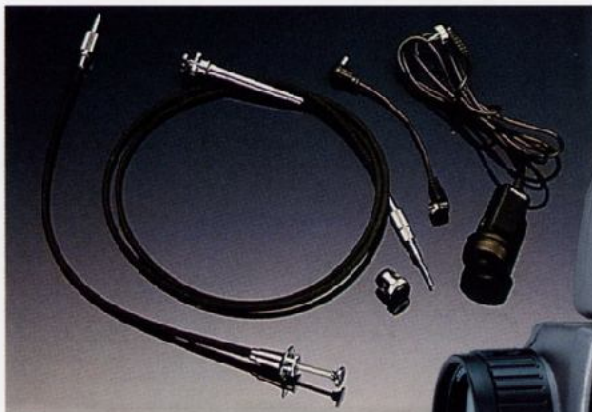

**REMOTE RELEASES**

When shooting using long exposures, a remote release can ensure that there is no chance of camera shake.



**METERS**

Even if your camera has the most sophisticated metering in the world, it is of no use in the studio if you are using synchronized flash units. For this you need a flash meter that will fire the flash heads and meter the output.



**AMBIENT LIGHT METER**

Manual cameras will need an ambient light meter. Here we can see the central spot being used.

pressure onto the camera release. The photographer's hand need not touch the camera to trigger an exposure. An air release has a similar effect, but the shutter is tripped by air pressure. The photographer squeezes a rubber bulb, the air compresses and pushes down a wire which in turn depresses the camera release.

**METERS**

Virtually all modern SLR cameras have built-in exposure meters which measure light reflected off the area seen by the lens. There are three main metering systems built into modern SLRs—zone or

matrix, center-weighted, or spot. In the zone system, the camera divides the scene it sees into 9, 27, or 100+ zonal areas and evaluates the light reading in each one. It then produces an exposure that places the median light value at the center of the exposure spread. All film and digital have an exposure spread of the number of shades that they can capture ranging from dark to light. Anything that is brighter than the top end of the range simply comes out as white and anything darker than the bottom end comes out as black. The camera will attempt to place the mid-point of its exposure range at where it thinks the mid-

point of the exposure values are in the scene, to correspondingly capture the widest range of exposure values. Using the zone system, if there is one bright spot or very dark spot it will not unduly influence the resulting exposure because the camera will realize it is some way off the scale of light it is looking at.

The next system is the center-weighted one and this can be very useful in glamour photography. Here the camera evaluates all the zones it can see, but then weights the exposure for area in the spot-shaped center of the image. If that is your model then all the tones of her skin are

guaranteed to be accurately reproduced, with consideration being given to the surroundings as well.

The final metering system is spot metering. All decent SLRs have this and it really is a waste of money to buy a modern SLR that does not offer the three main metering systems. Of the digital SLR cameras, only the Fuji S1 Pro fails to offer more than zone metering and this model has been superseded by the S2 now anyway. The spot system, needless to say, only uses the spot in the center of the camera reading to work out the exposure. This should only really be used

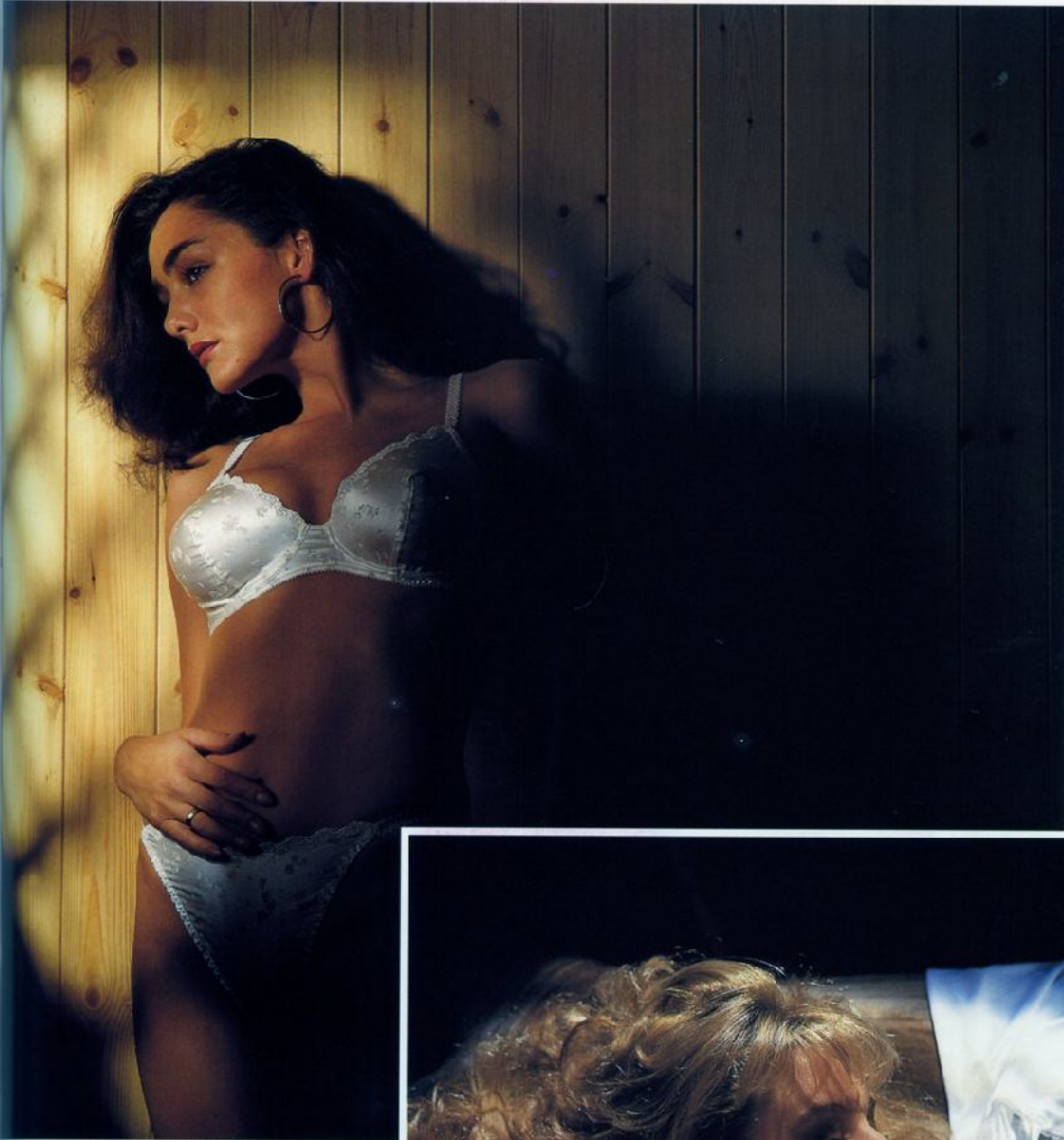

*In this photograph there are many dark areas that may affect the metering process. Therefore it is necessary to spot meter from a lightly shadowed area. If you are using print film, you should meter from the darkest area from where you would like detail to be recorded, and then add two stops for the actual exposure. 50mm lens, Kodachrome 64, 1/125th sec, f5.6*



*Center-weighted metering can be used to move the exposure range up or down without the risk of losing very much detail. Although it looks natural, the scene is lit by flash from behind a wooden frame to provide shadows. 50mm lens, Kodachrome 25, 1/125th sec, f8*





**FLASH EQUIPMENT**

*For professional results in the studio, dedicated flash heads are the only option. A softbox will give a more even and diffuse light than an umbrella.*

**FLASH GUN**

*A flash gun should be used carefully and rarely on full power. Guns with swivel heads can be used to bounce light from walls for a diffuse effect.*



when there are very challenging light conditions with extremes of light and dark that are confusing the other systems. With spot metering, whatever is in the middle of the spot will be well exposed, but there is no guarantee that anything else will. Fashion photographers tend to use it a lot and it can be very useful for circumstances such as shooting a model who is backlit by the sun or surrounded by highly-reflective materials. Water, it should be pointed out, is very reflective and will often fool metering systems resulting in the picture being underexposed.

**FLASH**

Instant light, in the form of a flashgun, is another useful addition to the photographer's collection of hardware. Most professionals shoot their indoor work by studio flash, but this is extremely powerful and has to be used in conjunction with mains electricity. You cannot use the SLR's built-in meter for use with studio flash and you cannot use your SLR in any form of semi-automatic mode, such as with a flashgun, when using studio flash. The reason for this is that

the camera can control the output of a flashgun and turn it off when the exposure is correct, but with studio flash the camera will only activate it. You must use your camera in manual mode, set the speed to one which the camera can synchronize with firing the flash (usually 1/125th or 1/250th but many cameras can synchronize at all speeds) and use the aperture based on the amount of light falling on the subject. To meter this you need a hand-held meter that can fire the studio flash. You simply dial in the ISO rating and speed the camera is using and then hold

the meter right in front of the subject. Press the fire button to activate the flash and the meter will tell you what aperture you need to get the right exposure. Studio flash starts from \$78 per unit and even the basic models have rudimentary power settings so that you can alter this and thus be able to use different apertures for creative effect. The better the quality of the flash unit, the more variable the control of the output.

Small flashguns are ideal on location. The light emitting from an electronic flashgun has a color

temperature practically identical to sunny daylight. The two sources can therefore be used in tandem without strange color casts appearing on the film. Where there is bright sunlight there is also deep shadow and no film can encompass that sort of contrast range. The flashgun can be used to fire light into areas of shadow that would otherwise be lost on the film.

Electronic flash can also be used as a main source of illumination in outside night shots. A single powerful gun may be enough to light some setups, but the very directional light that it throws may look harsh and unattractive.

A better solution is to use several guns at once, spread out to give a more even illumination. To synchronize them, you can either

connect each gun's lead to the camera via an adapter, or use slave units. These are photoelectric cells that are triggered by the flashing of the camera-mounted gun and in turn trigger the other guns. Their response is instantaneous.

## FILTERS

Filters fall into two groups—color-correcting filters and special-effects filters. Both types have a place in the glamour photographer's collection of accessories.

Conventional filters are circular and screw directly into the thread at the front of the lens. But the most popular type of filter system now is the interchangeable variety. You simply buy an adapter and a filter holder. The

adapter screws into the lens thread and the holder screws onto the adapter. Filters may then be bought singly as they are needed. The new system is more economic than the conventional one, because lenses have different-sized screw threads. In the past you might have needed to buy three versions of one filter to suit all your lenses, but with the new system, you simply buy three adapters and all your filters will fit on any lens.

All film is balanced either for daylight or for tungsten light. If you shoot daylight film in tungsten light the pictures will have an overall yellow/orange cast. This cast can be eliminated by using a color-correcting filter—in this case, an 8-B which is blue. The glamour photographer rarely runs into

trouble with color temperature, because he should be able to plan whether he is going to shoot his pictures in daylight or artificial light conditions. He can adjust his film stock accordingly. With digital the photographer has a great advantage over film—he can use the camera's built-in Automatic White Balance (AWB), which will automatically adjust the color temperature, allowing you to shoot under any lighting conditions. If the AWB system gets it wrong (and with lower light levels, it tends to) then the color temperature metering system can be used to take a reading from a white sheet of paper and the camera will then use this custom setting to ensure that there are no undue color casts. It is facilities like this that make digital SLRs much more powerful than film cameras.



(Above) Light sky tones often beg for the use of a filter. In the picture above, a pink graduated filter has added tone to a sky that originally looked rather muddy. Graduated tobacco filters are also favorites for dealing with otherwise dull skies. 24mm lens, Kodachrome 64, 1/60th sec, f4



(Left) A fine black mesh over the lens helped to diffuse the picture. Strong backlighting played a large part, too. Other alternatives are lenses made specifically to produce soft focus effects, and grease smeared over the lens. 150mm lens, Ektachrome 64, 1/125th sec, f16



(Above) The light on the model's face comes from a focusing spotlight that has two strips of colored gel (blue and red) over the lens. The central area was left clear and carefully placed across her eyes. The white wall in the background has been lit using two lights to which colored gel strips have been fitted. A red gel covers the light coming from the top left of the frame, and an orange gel covers the light coming from the bottom right of the frame. Each one blends with the other to make the graduated background. 50mm lens, Kodachrome 25, 1/125th sec, f5.6

Special-effects filters are likely to be of more use. The photographer can introduce mood and atmosphere by slipping a colored filter in front of his lens; the resulting picture will have an overall cast and will be significantly different from the original scene. The only danger here is when to use colored filters and which color to use. Overuse or misuse of colored filters can destroy a picture, although it is worth experimenting with a filter if you think there is a chance that your picture could be improved by the use of one. For the digital photographer, filters can also be used, but it is far more sensible to shoot without one and then tone or add a color later on using Photoshop. If the effect doesn't meet favor then you always have the original to go back to—there is no such luxury with film.

Graduated filters are becoming popular among professional photographers. The lower half of the filter is clear and only the top half is colored. They are particularly useful for reducing the brightness of the sky in cases where accurate exposure of the foreground would lead to over-

exposure of the sky. Again, the color must be chosen with care so that it adds to the impact of the picture. The most useful of these filters is therefore the neutral density version that simply reduces the contrast without altering the color. This is useful for digital photographers as well as film users. The colored versions can produce results best described as tacky.

True special-effects filters such as starbursts and image multipliers can be striking in a picture. However, the effect can tend to overpower the picture itself. You must bear in mind your list of impact priorities, the relative importance of each element, and make sure that the special effect fits into the shot at the correct level of impact. Most of the time you will not want or need to use this kind of filter and if you submit a host of pictures to a magazine or library having used them, your photos will be swiftly rejected. Once again, the digital photographer can add effects like these to see what the overall effect is like, without endangering the original.



Digital cameras have a feature whereby they can detect the color temperature of a scene and alter the white balance accordingly. However, it isn't foolproof and so a manual White Balance setting may be called for. In the top picture, the AWB has given the girl a peachy cast, whereas in the bottom picture, a manual WB setting was entered with a lower light temperature, resulting in a more healthy complexion. Olympus E-10 digital, 1/320th sec, f8



**FILTERS**

Polarizing filters only allow synchronized rays to reach the film plane; they remove unwanted reflections from surrounding surfaces and darken the sky. When the polarizing filter is passing polarized light (below) there is no effect on reflections or the sky. By revolving the filter you will block any polarized light and the sky will darken and reflections will be reduced. Olympus E-20P digital, 1/250th sec, f2.2

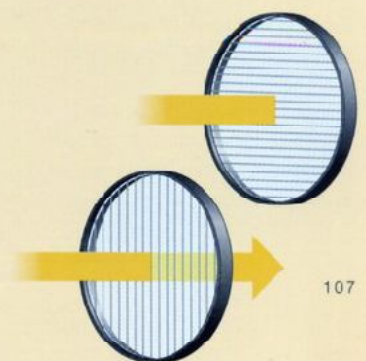

# LIGHTING CONDITIONS

It is impossible to underestimate the importance of light in photography. The Greek derivative of the word itself means "drawing with light." In film photography, the image is formed by the chemical reaction of silver halides to energy in the form of light. In digital, the image is created by the CCD (Charged Coupled Device) that turns the rays of light into individual pixels of light and color. Light can be distinguished in two ways; natural and artificial. Each type has its own properties that play a significant part in creating the mood of a shot.

Natural light, also known as available or ambient light, has a vast range that can never be fully reproduced under artificial conditions. Even though the light from the sun comes from a single source, a variety of effects is created by the position of the sun in the sky and the interference of atmospheric irregularities.

## EARLY MORNING LIGHT

When the sun rises in the morning it casts its rays across the earth at an oblique angle. This period lasts only a short time, but it is prized amongst photographers above all other types of natural light. There are two main reasons for this. Firstly, the sun's rays strike the sides of standing subjects. We are far more accustomed to seeing standing subjects lit from above, because throughout most of the rest of the day the sun is roughly overhead. The simple fact that the picture is illuminated from an unusual angle is enough to lift it out of the ordinary, even though the scene in front of the camera may be otherwise unremarkable.

Secondly, the quality of the light at this time of day is altogether different from that which occurs during the main part of the day.

Because the early morning rays are cast at a slant, traveling further through the atmosphere, the light is far warmer in color than at midday. Professional glamour photographers take every opportunity to utilize this warmth, because it suits the nature of their subject matter.

## EVENING LIGHT

The same effect occurs as the sun sets, and again it only lasts a very short time. However, there is a difference between the two times of day. The early morning light is usually clearer than it is in the evening, particularly near urban centers, simply because the day's activities stir up dust in the atmosphere. In addition, the land has become warmer during the course of the day and atmospheric conditions tend to produce a haze in the evening.

## DIRECT OVERHEAD SUNLIGHT

As the sun climbs higher in the sky, assuming that the sky is cloudless, the color temperature of the light cools. From being a warm orange it turns to a cool blue. The shadows shrink in length, becoming much harsher.

Strong direct sunlight makes good photography difficult. The contrast between light and shade

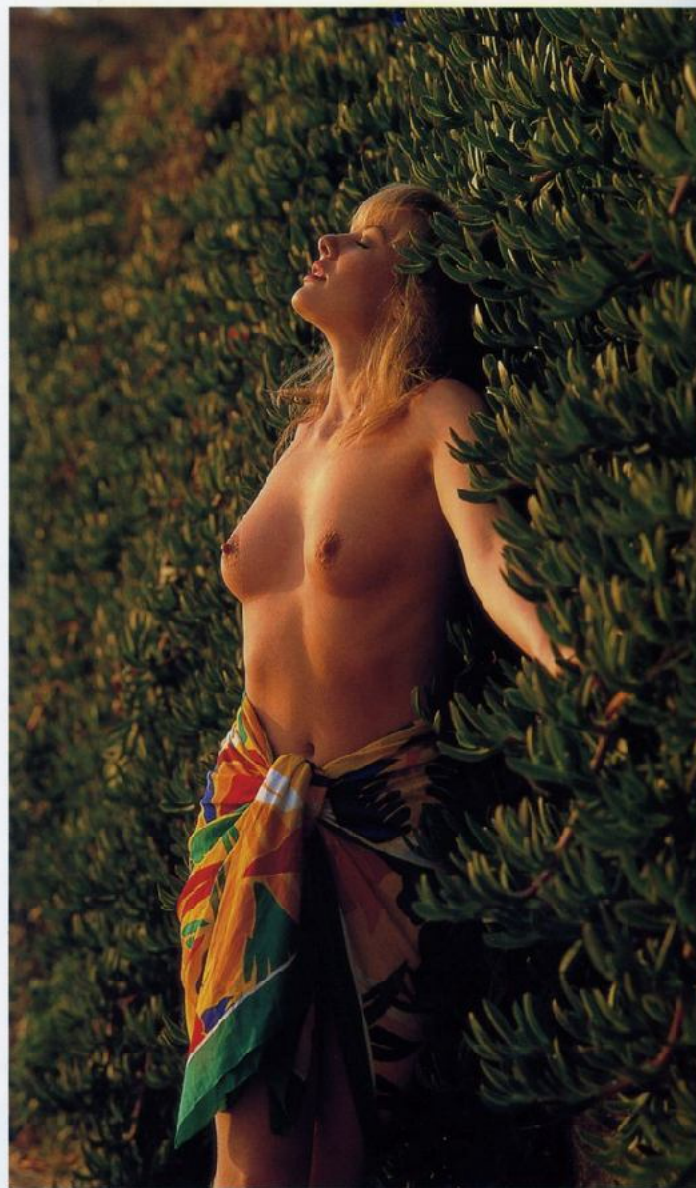

*(Above) Early morning sunlight is at its most golden, creating a warm glow—here it strikes the model almost sideways on.*

127mm lens, Kodachrome, 1/250th sec, f4

*(Right) Similarly, late evening can produce a warm and flattering light, although by the end of the day, a haze has formed in the air. This is something that can be used to good effect.*

35mm lens, Kodachrome 25, 1/64th sec, f8



*(Above) Cloud cover at midday produces very flat lighting conditions. Both highlights and shadows merge into an overall gray. The resulting pictures lack any sparkle.*

85mm lens, Kodachrome 64, 1/125th sec, f5.6

*(Right) Direct overhead sunlight presents the glamour photographer with problems. One solution is to make the model lie down, preferably on a light-colored surface. Her front will be lit by the direct sun, while her sides pick up light reflected from the ground.*

85mm lens, Kodachrome 25, 1/250th sec, f5.6



increases dramatically, frequently to the point where even modern films or CCDs cannot accurately reproduce both ends of the tonal range simultaneously. However, the photographer can turn this to his advantage. If parts of the scene are strongly lit and others lie in deep shadow, he can elect to emphasize either part by carefully framing his shot or alternatively by using exposure values that allow one part to disappear into obscurity, while correctly reproducing areas he wants to keep.

If strong vertical sunlight is causing the model's features to be unevenly lit, one solution is to ask her to lie down. She can then be photographed from above and slightly to the side, avoiding the camera's shadow from falling within the image area and creating even illumination.

In strongly directional sunlight it is particularly important to remember to meter carefully. You must decide what part of the image needs to be accurately reproduced and set an exposure

combination that will cope with it. For example, if you are photographing a model against a background of dark blue sea and shining white sand, your camera's meter will be affected by the variation in tones and will not necessarily give you the correct exposure for the model's skin tone. Always take the precaution of taking a reading directly off the model's body, both from the shadows and the highlights. The correct exposure would lie between the last two readings.

### DIFFUSION

If the nature of the shot you are planning is rather more subtle, you would be wise to avoid direct overhead sunlight as an illumination source. Some form of diffuser, such as material, that will spread the light rays and cut out the intensity is needed.

Cloud is a natural form of diffusion, but inevitably has its drawbacks—if the cloud cover is uniformly thick, the contrast would be reduced to a dull average gray. If it is patchy, the



*One solution to the problem of direct overhead sunlight is to place the model in dappled shade. Exposure for shots such as this should be midway between highlight and shadow light levels. 135mm lens, Kodachrome 64, 1/125th sec, f5.6*

light levels will be constantly changing, entailing frequent checks with the meter to ensure that the correct exposures are being given. This will be time-consuming and tedious. You may of course be lucky with the light—with even cloud cover forming the perfect diffuser. The chances of this occurring are, however, remote.

It is far more sensible to rely on a form of diffusion that you can control. The simplest way of getting round the problem is to stand your model in the shade. On a bright sunny day the shade is actually fairly light. It is only when you are trying to include both highlights and shadow that

contrast problems are encountered. If the whole scene is photographed in the shade, the photographer is effectively setting smaller boundaries on the contrast range he is expecting the recording medium to encompass. Incidentally, shade is not simply a monotone—some areas have highlights and shadow as well, although they are less obvious and tend to be overlooked.

However, finding a shady spot will restrict your choice of locations, and, more importantly, it will restrict the physical area in which you can shoot. One means of eliminating this dilemma is to shoot your pictures under a tree.

*Here the photographer has deliberately placed the model so that she is backlit by direct sunlight. A reflector placed to the left of the camera throws light back up on to the front of her body.*

*50mm lens, Kodachrome 25, 1/125th sec, f5.6*







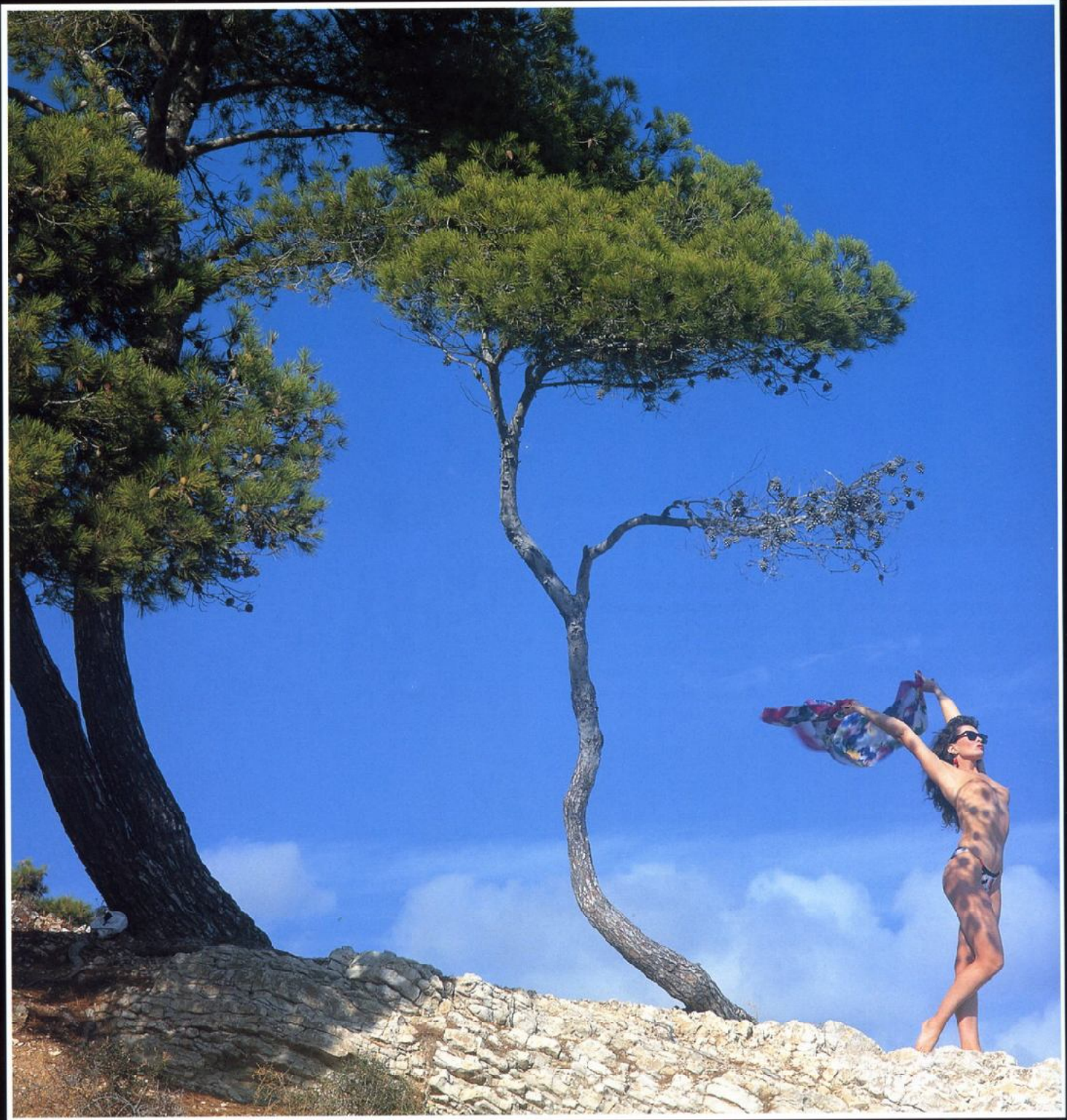

Light during the middle of the day is the least flattering. It also produces contrasting shadows and, with the sun so high, makes it difficult for the model to look into the sky. Here a tree is used to create variable shadows, the pose adds drama and the sunglasses allow the model to see what she is doing.

180mm lens, Kodachrome 64, 1/250th sec, f8

Sunlight will fall through the branches and create a dappled shade, an effect that is particularly suited to softer glamour shots.

### SHOOTING INTO THE SUN

Up until now we have been talking about situations in which the photographer is trying to avoid the effects of direct sunlight. But there is no reason why he should not use this to his advantage. The most obvious technique is the silhouette. By standing the model between the sun and the lens, and setting the exposure for the background rather than the model's skin tone, it is perfectly simple for anyone to produce this pure form of imagery. It works particularly well with the female nude, bringing the viewer's attention to the form of the figure. No extraneous details should be allowed to encroach into the image area or else the purity of the final product will be spoiled.

The term *contre jour* (against the day) can be applied to any picture in which the main source of illumination is behind the subject, such as the silhouette. However the term refers more typically to shots that actually include the light source within the image area. It is a technique that is well suited to glamour

photography, provided that it is used skilfully. The central problem is that the light source itself tends to dominate the picture and, unless you are trying for a semi-silhouette effect, this may not be advantageous. However, you can control the final result by judicious use of the exposure controls on your camera. Meter the part of the picture you want to reproduce correctly and set the camera's exposure settings accordingly. Although the light source will be completely overexposed in the picture, it is usually of no great importance. The sun, for example, will probably appear as a white ball.

Finding the correct exposure for shots like this is a question of guesswork to a certain extent, and the photographer is always well advised to bracket his exposures by at least one stop, if not two, each side of the indicated value. When using digital the advantage is that you can check the outcome on the CCD and adjust the exposure accordingly. The point to remember is that you are trying to marshal far more light than would normally be the case, and in this situation, even the best meters will not always be accurate. By bracketing, you will be giving yourself the best chance of success.

### THE CHANGING POSITIONS OF THE SUN

The quality of light changes all the time, and the glamour photographer must be able to recognize and harness the variety of effects that the movement of the sun creates.



**Early morning** For a short period just before dawn the sun's rays strike the earth from an extremely oblique angle; the air is usually very clear. Side-lit verticals take on a three-dimensional quality.

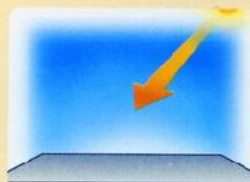

**Mid-morning** As the sun climbs the shadows shorten, the air becomes more dusty and the temperature rises. The sun's angle makes it ideal for using vertical white surfaces as reflectors.

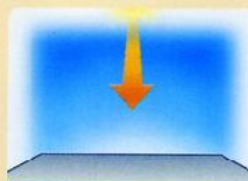

**Midday** Clear skies and strong sunlight produce dramatic shadow effects, but contrast increases as well, making it difficult to encompass all the tones correctly in one frame.

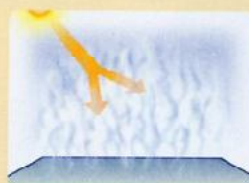

**Heat haze** Heat haze in the early afternoon is a form of natural diffusion, and makes subjects look more distant than they really are. A skylight or UV filter will help to cut down the haze.



**Scattered clouds** Scattered cloud cover means that the light levels are constantly changing, and the photographer should adjust his exposure values accordingly.

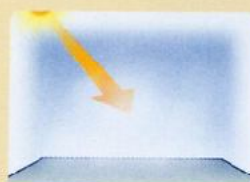

**Fog and mist** Fog and mist reduce contrast levels, so that even the most colorful subjects look washed out and faded. They also act as diffusers, spreading the light evenly.



**Sunset** Sunset is similar to dawn—the light falls obliquely. It is also much more orange than noonday light. This can be very useful if the glamour photographer wants to warm up the model's skin tone.



(Left) Backlighting has the effect of introducing distance between the subject and the background. If handled correctly it will highlight the model's hair. In the case of this picture, the model's body is also given a highlight down one side. Exposure calculations should be made from the darker tones, and the highlights should be allowed to burn out. 50mm lens, Kodachrome 64, 1/60th sec, f5.6

(Right) The model has been turned at an angle to allow shadows to form across her torso, while the edge of the sun generates a hazy flare effect. Olympus E-20P digital, ISO 80, 1/320th sec, f11



film plane and can possibly upset the balance of the shot. SLR users have an advantage in that they can usually see flare as it occurs and before they have taken the picture. Therefore they can estimate how much the shot will be affected visually. Flare can be combatted by using a lens hood or even a piece of card held to the side and in front of the lens so that the front element is actually in shadow.

## REFLECTORS

One of the problems that constantly faces a photographer working with natural light is that he cannot move the light source to better suit his purposes. In many cases it is possible to move the model to another position that allows light to fall from a better direction. But occasionally, particularly if you are using an immovable prop, this just is not feasible.

The answer is to use reflectors. These take many forms; a white wall reflects a surprising amount of light; the sea, if the sun is at the right angle, also throws off a tremendous glare. A photographer who wanted to photograph his model amidst a forest of skyscrapers once used the light reflected from the mirror windows to illuminate her.

However, most of these reflectors are immovable and therefore present largely the same problems as the sun. Undoubtedly the most convenient type of reflector is a plain white sheet of

## LENS HOODS

Lens hoods are invaluable when working in intense sunlight. By shading the front element of the lens they prevent the refraction of strong light within the lens's optical system. There are various styles: 1 Built-in sliding hoods, common in long-focus lenses. 2-3 Detachable hoods to suit different focal lengths. 4 Rectangular hoods which only work on bayonet fittings. 5 Collapsible rubber hoods. 6 Adjustable bellow shades.

## FLARE

When shooting into a bright light, you run the risk of letting flare creep into the picture. Of course flare can, like any optical aberration, be harnessed to become another element to fit within the shot. However, the tell-tale streaks of scattered light that denote flare will undoubtedly form a powerful part of the image if they are allowed to reach the

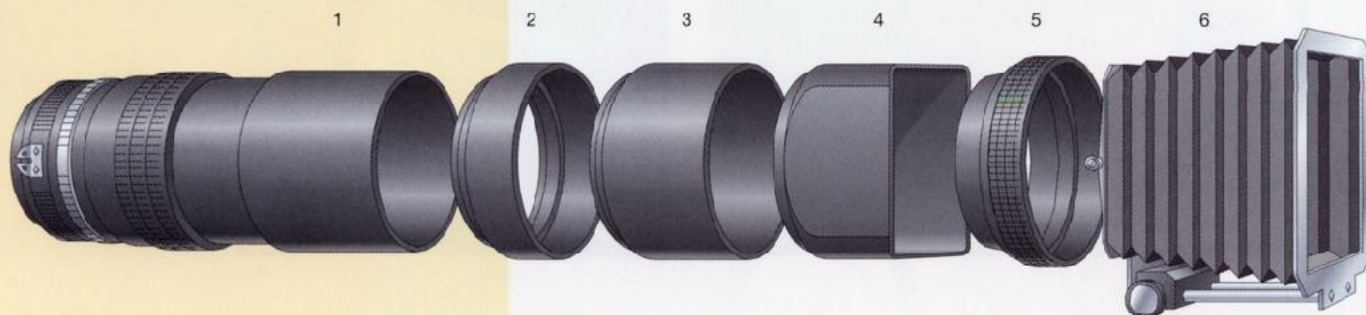

cardboard. It need not be too big—3 ft by 2 ft (1m by 65cm) should suffice for most purposes. It is easily moved and can be used to fill in shadows and reflect light into whatever shady corner you desire. More commonly used are inexpensive gold or silver reflector sheets, panels, or umbrellas. There are differing types, some which offer subtle diffuse reflection and others that bounce almost all the sunlight back again. They are available in different sizes and can be handheld or otherwise mounted onto a tripod.

### NATURAL LIGHT INDOORS

Supplies of natural light are not confined exclusively to exterior locations. It creeps indoors as well, but rarely in large quantities. The daylight that comes through windows is usually soft, subtle,

and muted, ideal for a glamour photographer trying for a more romantic image.

If it is very bright and sunny outside and there is a room with white walls and plenty of windows at your disposal, you should try some indoor shots. The sun's rays will have bounced off the landscape, through the windows, and off the walls before they fall onto the model; as a result they will hardly be directional at all, and the shadows will be practically indiscernible from the highlights.

Photographic conditions are rarely perfect, and although the quality of indoor daylight may be wonderful, the quantity will, in all probability, be insufficient. Exposure times may become so long that a tripod becomes necessary. But it is worth persevering, even though your



### CONTRAST

Professional photographers cannot afford to take too many chances with their pictures. If, for example, the contrast ratio is particularly high, and they are using 35mm film, they frequently "bracket" the shots. If the meter suggests an exposure of 1/250 at f8, they will shoot one frame at that level, then another at f5.6, and another at f11. If they particularly want to use f8 for the aperture, they move the shutter speed dial a stop either way. The examples (left) demonstrate shots taken using exposure times of 1/60th sec (top), 1/125th sec (middle), and 1/250th sec (bottom).



model may have to stay still for longer than she is used to.

Do not make the mistake of posing her in a pool of direct sunlight that is coming through the window. The contrast between direct and reflected sunlight will probably produce a harsh result that spoils the effects that could be achieved by sticking with one or the other. Inevitably, there is an exception to this. Strong sunbeams falling through windows can be used. Pose your model in the ray and frame her in the viewfinder in such a way that you include both her figure and the surrounding area; set your camera to expose for the ray itself. The surrounding area will go dark in the final image and the model will appear to be caught in the sunbeam as if it were a spotlight. It is not an easy effect to achieve, and you are best advised to bracket your

exposures in order to ensure that at least one of them is correct. Even shooting digitally you can set the camera to automatically bracket, thus saving time.

Reflectors are useful indoors as they can be positioned in front of windows to throw light sideways into shadier areas of the room. It is quite feasible to increase the light on your subject by a couple of stops in this way, which may mean the difference between the camera being handheld or mounted on a tripod.

## ARTIFICIAL LIGHTING

The great advantage of shooting in the studio is that the photographer can control the lighting conditions. He does not have to worry about the sun disappearing behind a cloud at the critical moment, or sudden gusts of wind. If he wants more

light in the studio he can turn it up, or change the angle of illumination by simply moving the light stand.

There are all sorts of artificial lighting systems, but the two most commonly used by glamour photographers are tungsten and electronic flash, the latter usually being the first choice of the professional. However, digital cameras are more flexible as they can additionally cope with the color cast problems of tungsten lights more easily.

## ELECTRONIC FLASH

The heart of a studio flash system is the power pack; a large capacitor feeding from the mains. Several flash heads can be plugged into the power pack and the output of each can be varied to suit the photographer's needs. Flash heads take many forms but

the most common is the single unit with a flash bulb inside. There are also units which are the flash equivalent of spotlights; fish fryers, flat rectangular frames that throw an even diffused light; and strip lights, long narrow frames with a flash head running the whole length. Each type has its own purpose.

The single units are used to provide directional light. For example, the photographer might want to throw light onto only a model's face, in which case he would use a single unit. The quality of light emitting from these units can be altered by the use of various attachments.

If the photographer wants to closely define the area into which the light falls, he can slip a narrow reflector over the flash tube. He can also fit barn doors. These have hinged metal wings



(Left) This picture shows John Kelly at work on location in the West Indies. The swimming pool is in the shade and Kelly has chosen to use gold foil reflectors to bounce a warm light on the model's body. This brings the light levels up to an acceptable level and permits the use of 25 ISO film and a handheld camera.

(Far left) This picture was taken during the same session. The model's skin has taken on an attractive, warm, golden glow thanks to the light bounced on to her body from the gold foil reflectors. 85mm lens, Kodachrome 25, 1/125th sec, f8



## REFLECTORS

Reflectors can be very useful to the glamour photographer. They can throw light into shady corners and fill in harsh shadows. There are many kinds of reflectors. Hand mirrors are very powerful, but their effect can sometimes be too obvious. Crumpled silver foil, pasted down onto a piece of card (left) is another strong reflector. A plain white sheet of cardboard can also be effective for softer fill-in light.

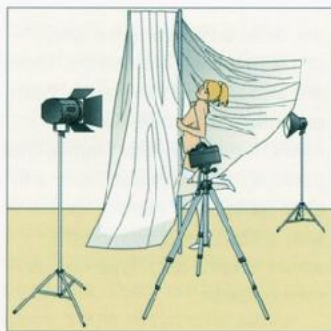

*(Below) In this shot, a light was placed behind the net curtain, while the light on the model came from a focusing spotlight with a cutout mask placed in the gate. This gives two distinct areas of hard light. The picture has been turned 90 degrees with the camera tilted to give the impression that the model is lying down. 50mm lens, Kodachrome 25, 1/125th sec, f16*



*(Center) This was shot with the model standing against a gray wall. The whole scene was lit with a hard light, covered with a red gel, giving the photograph a red tint. So as to restore the model's face to her natural color, white light was directed through a screen—in this case a venetian blind—adding interesting shadows. 75mm lens, Kodachrome 100, 1/125th sec, f22*



*(Right) You do not need numerous light sources to take an interesting picture. This shot was taken with just one hard light, placed high and to the right. A background was created by simply draping an old dust sheet over a chair, forming interesting shadows, but not detracting attention from the model. 50mm lens, Kodachrome 100, 1/125th sec, f16*



protruding from each side that can be moved to cut down the spread of light. He can also use a snoot; a hollow cone that fits on the front of the light. This will restrict the light to an extremely narrow pool.

Alternatively, he could avoid strong directional illumination by fitting a diffuser. This may be an opaque disc or a reflector bowl fitted with either wire mesh or a cap that cuts off direct light from the flash tube itself. However, the most commonly used diffuser is the softbox that fits over the flash head and offers a large, square, diffuse source of light. All makes of studio flash head have a supporting accessory range that includes the softbox, which is the professional's choice.

The "fish fryer" throws a light that is roughly comparable in quality to daylight coming through a window. The photographer uses

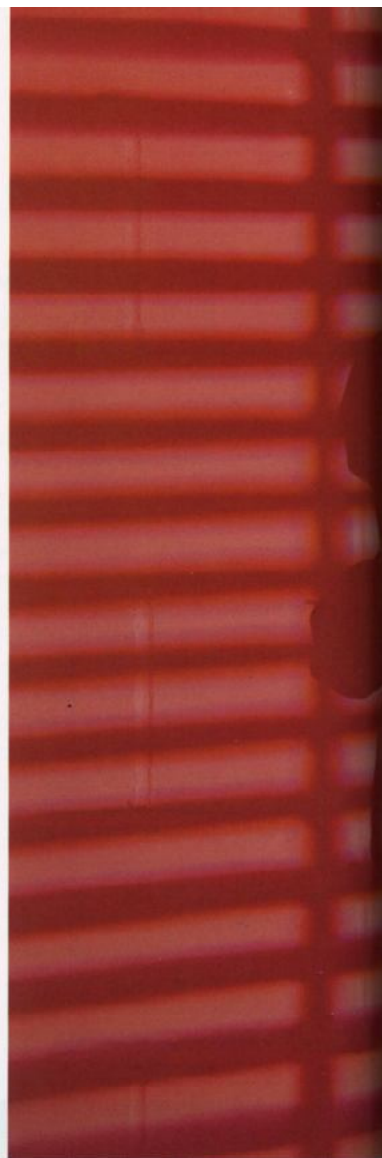



**ALTERNATIVE LIGHT SOURCES**

*The "fish fryer" (above left), a large window light, provides an even spread of light over a wide area. The pivoted arm, pulley, and barn doors all combine to make a very flexible light source, making the fish fryer a popular choice in photographic studios. The "swimming pool" (above right) is a larger version of the fish fryer. It provides a very broad spread of diffused light, giving flattering shadowless results.*

it to provide an even spread of light over a fairly large area. Larger versions, known as "swimming pools," are often used to provide general soft illumination over a whole scene.

Strip lights, particularly if placed either side of a background, throw an even spread of lateral light.

Second to the softbox in popularity stakes, and now more employed on exterior shoots, is the umbrella. A single unit is fired into the bowl of the umbrella and reflected back onto the scene. This combination provides both diffusion and direction. Silvered umbrellas produce a harsher shadow but give more light intensity than plain white ones, and gold umbrellas can be used for a sunnier effect. It is possible to obtain even greater diffusion by firing a flash straight through an umbrella.

There are many advantages of electronic flash over tungsten light. It enables the photographer to use daylight film; the studio will remain cool even if a session lasts for many hours; and electronic flash heads are less prone to failure than tungsten lamps. Studio flash can be expensive with leading name equipment costing \$2,200 for a power pack and two flash heads. However, there are cheaper alternatives and if you don't need to run the units in a blaze of light they can be powered from a regular mains supply. Flash heads can start from as little as \$75, though these offer only around f8 to f11 for maximum light power, while a more powerful model, capable of giving out f22 standard light, can start at around \$225. Many flash heads also offer a modeling light, giving you a better idea of where light and shadow will fall when the flash is fired.





*This picture was shot using a full set of three studio lights. The first lighting unit, bounced into an umbrella, was placed high and to the front of the model. The second is an open studio light, placed to the left of the frame and lighting up the background. The third light source is on the right and to the back of the model. It is fitted with a snoot, creating a warm orange glow down one side of the model's body and separating her from the background.*

50mm lens, Fuji Provia, 1 sec, f11

switched on and switched off on a regular basis, it will shorten their already relatively brief life expectancy, and they often blow at the instant of being turned on. This means that if you want to keep the studio cool you do have to pay a price in blown lamps. It makes sense to have plenty of spare bulbs on hand when you are shooting.

### **MIXED LIGHT SOURCES**

The glamour photographer can employ natural and artificial light sources at the same time. For

example, when the contrast range in a scene is greater than the film can handle, it is possible to boost the darker area with the aid of a portable electronic flash gun. This will reduce the contrast range and allow the photographer to correctly expose the whole frame instead of leaving one part to either over- or underexpose.

The key to this technique lies in the fact that electronic flash is balanced for daylight. In other words, the color temperature of the light emitted by the gun is theoretically closest to that of daylight at midday. Both light

**DIFFUSING AND REFLECTING LIGHT**

Two ways of diffusing and reflecting electronic flash are illustrated in this diagram. One basic method is to bounce light off a large white or neutral surface, such as a ceiling or wall (top right). The sensor should, if possible, still point toward the subject so as to give the correct exposure. If the head of the flash unit cannot be moved independently of the sensor, you will need to increase the exposure. Another method is to wrap a piece of white cloth around the flash head taking care not to cover the sensor (bottom right). A studio umbrella on a light stand (far right) is another good method of diffusing and reflecting light.



**TUNGSTEN LIGHTING**

It used to be that tungsten lighting was the poor man's flash. However, thanks to the popularity of studio flash, it is now as cheap, or cheaper, than the same setup with tungsten lamps. The advantage of using tungsten is that you can see exactly where the light is falling and control it precisely. For creative use this flexibility will save time over using a flash system where some degree of trial and error is always present, unless the setup is very straightforward. It is important to remember that tungsten light throws out a different color temperature to that of daylight or flash. It is a warmer light source. For the digital photographer, tungsten is much more friendly because of the AWB advantage, but for film users the photographer must resort either to film that has been formulated to take account of this bias, or use a blue filter to correct it.

It is also worth bearing in mind that, unless you have huge lamps such as are used for cinema photography, you will only have a limited amount of light with nothing like the intensity of flash. The demand is therefore greater for slower shutter speeds and wider apertures.

The build-up of heat in a tungsten-lit studio can be tremendous, making it an extremely uncomfortable environment to work in, particularly for the model on whom all the heat is focused. The camera will pick up beads of perspiration, her makeup will run, and the results will look awful. So make sure that the lights are switched off whenever you have to break for any length of time and also that the studio is well ventilated with fresh air. Tungsten filaments are not as fragile as they used to be but they are still not as sturdy as flash units. Be careful when you are moving the lamps. If they are

*By lighting the model with a portable flash unit held under the camera, the photographer created fierce shadows behind the girl. In this picture it has been done deliberately to add drama. Usually a portable flash unit is placed in the hot shoe of a 35mm camera, although it is not the best place because light from the flash reflects back from the subject's retinas and shows up on the film as red. The easy way around this problem is to mount the flash unit on a bracket to the side of the camera. 85mm, Kodachrome 64, 1/60th sec, f11*





*In this picture, daylight has been filtered in from a window to the right and behind the model, but the main sources of illumination were two tungsten lamps; one just beside the camera and the other to the left of the model. The warm orange tones have come from the tungsten lamps.*

50mm lens, Ektachrome 64,  
1/64th sec, f16

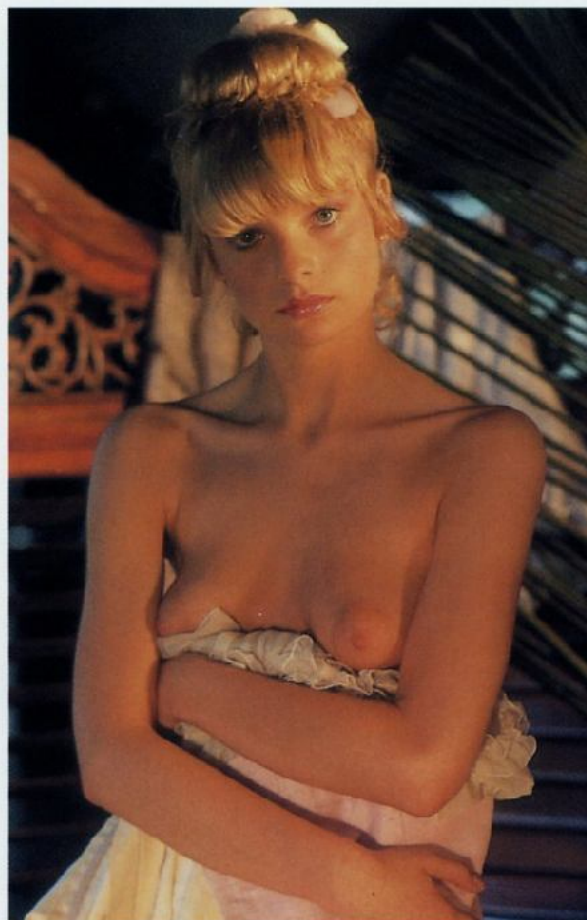

sources should mix without it being possible to spot the join in the final shot.

However, in practice this does not always occur, primarily because the color temperature of daylight is always changing. In the mornings and evenings it is more orange than it is at midday. The change from warm orange to cold blue takes place so gradually that it is imperceptible to the human eye. The color temperature of the light emitted from an electronic flash gun, on the other hand, is constant. The chances of the two being identical are fairly remote.

### **FILL-IN FLASH**

The mixture of natural and artificial light sources is least noticeable when the picture is taken in bright, direct, overhead sunlight. If the photographer uses

a flash gun to fill in the shaded parts of the model's body, the result will look as near natural as is possible. This technique essentially fulfills the same function as a reflector, but offers even more illuminative power to the photographer.

When mixing two light sources in this way, it is important to be clear about the exposure values. By using fill-in flash, you are, in effect, taking two pictures at once—one of the section of the scene illuminated by daylight, and one of the darker parts that will be lit by the flash gun. As a general rule the flash exposure should be half of that which would be required if the shot were to be lit solely by flash.

With a manual flash the lens aperture should be selected according to the power of the gun and the distance of the

subject from the flash, as directed by the maker's instructions. It is usually advisable to close down the suggested aperture by one stop for fill-in shots; this takes care of the small amount of daylight that will inevitably creep in when the flash exposure is made.

After selecting the aperture, take a reading of the main picture area with either a handheld meter or the one built into the camera. Simply adjust the shutter-speed dial until the meter tells you that the combination of the pre-selected aperture and the shutter speed will give you a correct normal exposure.

To achieve satisfactory fill-in flash with an automatic flash gun, it is necessary to fool the gun's sensor. This light-sensitive cell measures the light reflected back from the subject and cuts off the

flash when the level of illumination reaches a point that is adequate for the type of film in use. By setting the sensor control to a value one stop larger than the aperture in use, the flash gun will supply only half the correct amount of light, with the rest coming from available daylight.

Fill-in flash (or synchro-sunlight, as it is sometimes known) is a fairly unpredictable technique, simply because you have to assess two separate exposure levels to produce one correctly exposed image. When using this technique it is always advisable to bracket your exposures by at least one stop either side. When using digital always check the exposure by reviewing the picture on the LCD screen.

The light that emerges from an electronic flash gun is particularly harsh; without diffusion it is strongly directional, throwing jagged shadows. If the gun is mounted on the camera and the model is looking directly at it, there is a strong possibility that reflections from her eyes will give the red-eye effect. Many glamour photographers therefore avoid using electronic flash. Although, through diffusion and multiple flash setups, this problem can be eliminated.

*(Left) The main light source used here has been placed behind the model. To avoid casting her face in dark shadow, fill-in flash has been used.*

75mm lens, Kodachrome 64,  
1/60th sec, f8

## SHOOTING IN A STUDIO

The main advantage of shooting in a studio is convenience. All the technical paraphernalia required for photography is centralized in one place. Any item that is unexpectedly needed can be obtained quickly from known sources.

Naturally, this method of working holds great appeal for the professional whose costs require him to operate both speedily and efficiently. But the price to pay for that convenience is that studio rents can be exorbitant and sophisticated equipment is also expensive.

However, this does not mean that the serious amateur photographer cannot try his luck under studio conditions. He has two alternatives. Firstly, he can rent a studio for the length of the shoot, complete with equipment and possibly a model or, secondly, he can convert his garage or spare bedroom into a home studio.

Finding a studio that can be rented by the day or even by the hour should not be a problem in most of the larger cities. It is important that you know exactly how big the studio is and what equipment is available. These factors will undoubtedly have a bearing on the way that you shoot your pictures. If the space is tiny, you may find that you have to resort to using a wide-angle lens in order to frame your shot correctly, although by doing so you will risk ugly distortions of perspective in your pictures.

Studios generally have an assortment of lights that are available for use. If you know what they have in advance, you can plan your shoot to take full advantage of your rental fee. If you only possess a 35mm camera, it is worthwhile asking whether you can hire a 6 x 7cm camera for the period of the

*(Right) Studio conditions are particularly suited to glamour photography, simply because the photographer has complete control over light, heat, sounds, props, clothes, and, perhaps most importantly, privacy. Many models prefer to work under studio conditions because they can concentrate on the task in hand without fear of outside interruption. Make-up and wardrobe facilities are available for revamping the image during the course of the shoot. Here, the photographer has deliberately set out to recreate a classic Hollywood pose.*

90mm lens, Ektachrome 64, 1/125th sec, f5.6

*(Below) More specialized shoots featuring fantasy or surreal themes are possible when the photographer has complete control over the background and lighting.*

90mm lens, Kodachrome 100, 1/125th sec, f22

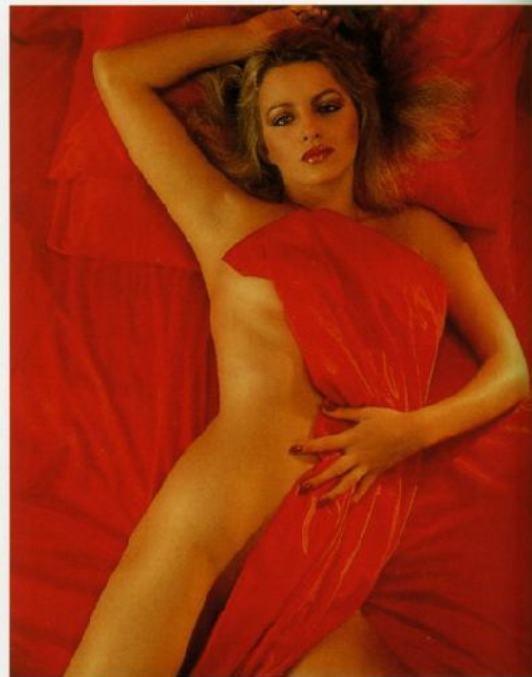

**STUDIO SPACE**

Every studio varies, but there are certain basic requirements that need to be fulfilled if you wish to convert a room into a studio for glamour photography. The most important thing to ensure is that you have sufficient space in which to work.

**Dressing room** The model will need a dressing room with a large, well-lit mirror, so that she can apply make-up easily, and has hanging space for her clothes.

**Storage space** You must have a storage area so that essential equipment, such as background rolls, hardboard, polystyrene sheets, and tools for building and repairing sets, is within easy reach, but can be kept out of the way when not in use.

**Extractor** An extractor is essential if you have sealed windows, as the buildup of heat from the camera lights will make the studio impossible to work in unless there is adequate ventilation.

**Seamless background roll**

Available in several different colors, this is ideal if you want to shoot against a plain background.

**Working space**

There must be adequate working space in your studio. The walls should be white, and if there are existing windows, these will need to be blacked out with a light-tight roller blind.

**Props** Since space is at a premium it is essential that furnishings and props are chosen carefully and kept to a minimum. Pot plants, brightly colored cushions, and pieces of material are always useful to have on hand.

**Film changing room****Film storage freezer**

**Trestle table** This is an essential item for building and repairing sets.

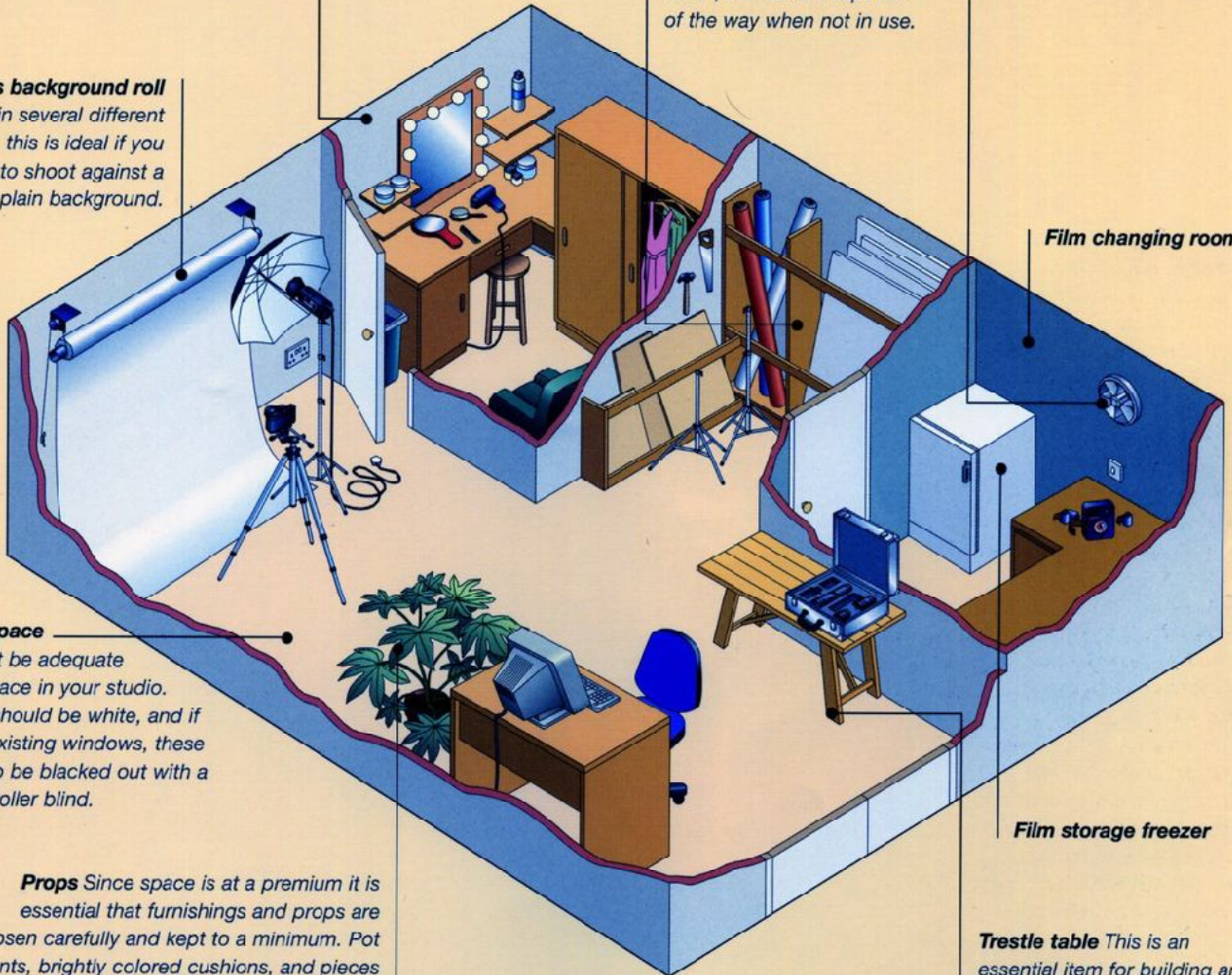

shoot. It will not cost much, and if you are trying to sell the resulting pictures your potential customers will prefer the larger format.

It is likely that the studio will have a list of experienced models who will work for the semi-professional model rates. As they know the studio they are more likely to feel relaxed and happy about the idea of being photographed by a stranger. This is a great advantage when you only have a limited time in which

to take your photographs. The studio is also likely to have a collection of props, and possibly even a wardrobe of clothes which will be available for use.

The more services that you use, the more it will cost. But if you balance the cost against the saving in time and effort, there is probably not much difference. When you are dealing with a rented studio remember to find out exactly what is available, and make notes, taking it all into account during your planning.

By opting to take your pictures in a home studio you are committing yourself to a greater investment of your own time. A room will have to be transformed; removable blackouts will have to be made to fit over any windows; you will have to organize some form of background material that can be changed if the need arises; the room will have to be heated; you will have to buy lights, props, and possibly clothes, as well as a comprehensive range of photographic equipment.

The advantage of a home studio, however, is that it can be used at any time, for as long as you want, and at no extra cost. This means that one of the constrictions normally associated with any photographic shoot—the time factor—is removed. Provided that you can come up with an interesting idea and execute it in a technically competent manner, there is no reason why anyone should suspect it was taken in your garage or bedroom, rather than in a professional studio.





*(Left) In this studio shot, the background is a detailed fabric that matches the pose and styling of the model to give an upmarket look. Just one flash head is used to light the model from the side. 127mm lens, Kodachrome 64, 1/125th sec, f4*

*(Below) The advantage of shooting in the studio is that you have the time and room to set up shots like this. The model is entirely lit by all the candles with no extra lighting needed. 90mm lens, Kodachrome 64, 1/2 sec, f5.6*

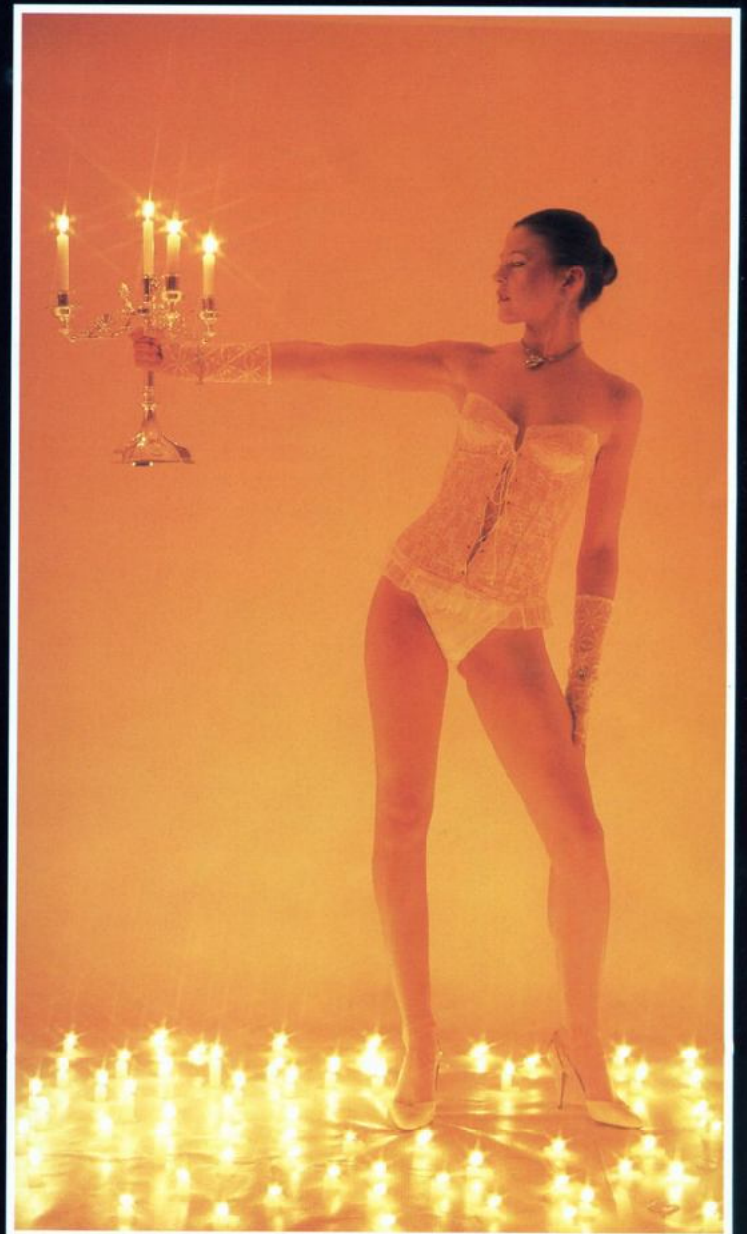

*(Left) Oil, colored gels on the flash heads, and reflective surfaces have been used in the studio to give this image a sensual feel. Two units were used to light the scene. 50mm lens, Kodachrome 25, 1/125th sec, f8*



# SHOOTING ON LOCATION

By choosing to shoot on location you are taking a series of risks, but if the shoot is successful you will gain all sorts of advantages that are not even available in a studio. When discussing location work, it is necessary to distinguish between exterior and interior as each brings a set of obstacles that have to be overcome.

## OUTDOOR LOCATIONS

The biggest problem with outdoor location work is the weather—the wrong kind can destroy a shoot very effectively as the photographer has no control over it. If your camera breaks down, you can use a spare. If the model falls ill, you can hire another. However, if you need sunshine and it rains, there is nothing you can do about it.

It is not surprising then that big-budget calendar or magazine shoots are nearly all conducted in places where the weather is relatively reliable. It is no accident that Hollywood, film capital of the world, is in California. The early movie moguls were well aware

that California has, on average, more hours of sunshine than any other comparable part of the country. When you are in charge of spending thousands of dollars a day, you need that guarantee of good weather.

However, there are not many photographers who can afford to fly themselves, their assistants, their models, and their equipment to exotic far-off parts of the world where there is a virtual guarantee of sunshine. That said, for the eager amateur, the rise of low-cost airlines means that if you are flexible about when you do your shoot you can organize very cheap flights for all concerned. An anecdotal example of this concerns a British photographer who needed to do a beach and bikinis shoot with two models at the end of May. The original plan was to drive to Cornwall in the UK, for the excellent beaches and surf. However, the shoot needed to be done at the end of May and the trouble with British weather is that it is entirely unpredictable. With only a one-day budget to spend on the shoot and a 700-mile round trip

by car, disaster was all too possible. Fortunately our intrepid photographer decided to plan ahead and managed to buy return tickets for himself and two models to Ancona in Italy on the Adriatic coast for next to nothing. By forward planning, the adventurous photographer with a flexible schedule may find it cheaper to go overseas.

The only other way that you can increase your chances of encountering the right weather conditions is by phoning the weather service before you set out. If the forecast is bad, you should contact all the people involved and call the shoot off.

Professionals do have one safeguard—weather cover. This means that they arrange the shoot in two or more parts, at least some of which can be conducted indoors. If it rains, they do the indoor part and then hope that the weather clears up in time to do the rest.

When choosing an exterior location it is important to know what sort of problems might

arise. For a glamour shoot you will need privacy. This means finding a spot where you are sure you are not going to be disturbed. Your final choice is likely to be somewhere isolated, and possibly hard to reach. However, try and arrange it so that you do not have to walk any great distance from your base vehicle. You will have a lot to carry and, if you forget anything, time will be wasted fetching and carrying.

When you set out on your reconnaissance, make sure that you ask the permission of whoever owns the land. A trespass charge could land you in court. When you find a potentially suitable spot study it carefully. Note the position of the trees, hedges, and walls to try and envisage what it would look like in early morning or evening sunlight. Pay particular attention to the horizon line. Take photographs of the spot, so that you can refer to them when you are coming to make your final choice. It is a good idea to note down details of possible locations on a set of file cards,



## CHOICE OF LOCATIONS

*Location photography brings its own risks and rewards. The appearance of glamorous underdressed models in remote spots tends to draw crowds of local onlookers (left), which may impose limits on your composition (and your composure!). It may also attract the attention of the local police who, by and large, do not welcome the intrusion of photographers and their models as it tends to pose a threat to the peace of the neighborhood. It is far better to find a remote spot where you can shoot freely without risk of intrusion. To reach the location (right), the photographer and model had to swim up the river, with the camera equipment wrapped in a plastic bag. The result, in the end, made it all worthwhile.*

*24mm lens, Kodachrome 64, 1/30th sec, f2.8*



*It is important to make the most of a location. The crusader castle on the island adds an exotic atmosphere to the picture. The photographer has chosen a strong viewpoint and shot the picture with a wide-angle lens that gives an expansive vista, and therefore more location value. He has also managed to make use of the strong breeze that was blowing over the Red Sea at the time. The sky has been warmed with a yellow filter.*

24mm lens, Kodachrome 64, 1/250th sec. f11

attaching any relevant pictures. The cards will form the foundation of a useful location file that may save you a lot of wasted time in the future.

Once you have selected your spot, there remains the question of transporting the people and equipment to the appointed place. If your location is in the middle of nowhere, it would be preferable to assemble everyone and everything before you set out. If you tell the others to meet you at a bar near your chosen location, it is extremely likely that

someone will break down, or go to the wrong place. Because of this, ensure that everyone has a cell phone and that you all know each other's telephone numbers. If someone does get lost then at least you will be able to give them directions. It's safer still for all the party concerned to travel together.

Good organization is absolutely essential if a shoot is to run smoothly, so make sure that everyone knows exactly what they are required to bring with them, even if that means giving



each person a typed list of necessary equipment.

## INTERIOR LOCATIONS

Interiors are generally easier to handle than exterior locations, but they do require some thorough research before the shooting can begin. The key thing to remember about location interiors is that you are likely to be shooting on someone else's property. If it is private property it is essential to brief the owner correctly before you bring down your shooting team. If it is public

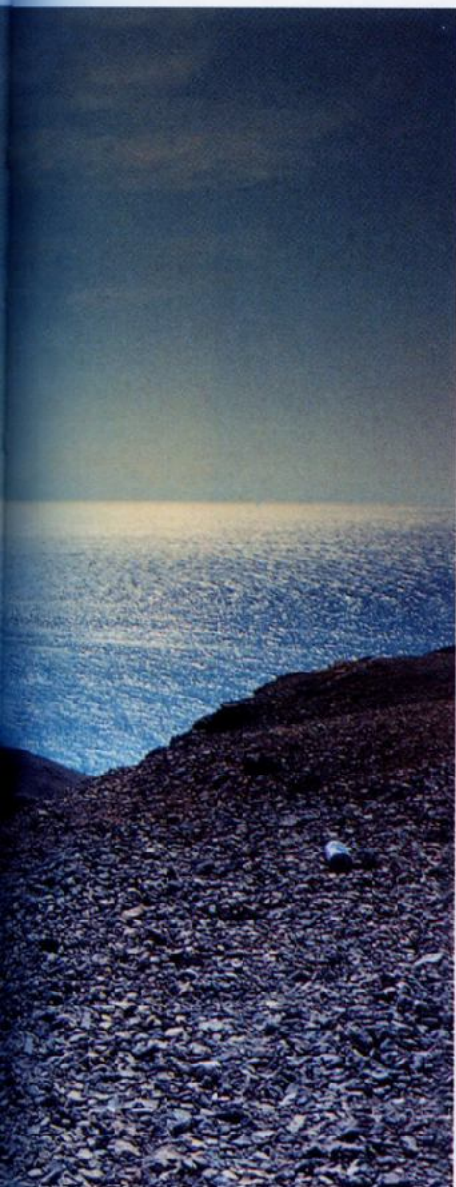

### CAMERA CARE

You should always take cleaning equipment with you on location. Sand and dust can cause serious damage if they are allowed to remain in the camera. The illustration (right) shows a basic cleaning kit: cans of compressed air (1), blower brush (2), stiff toothbrush (3), soft cleaning tissue (4), cotton swabs (5).

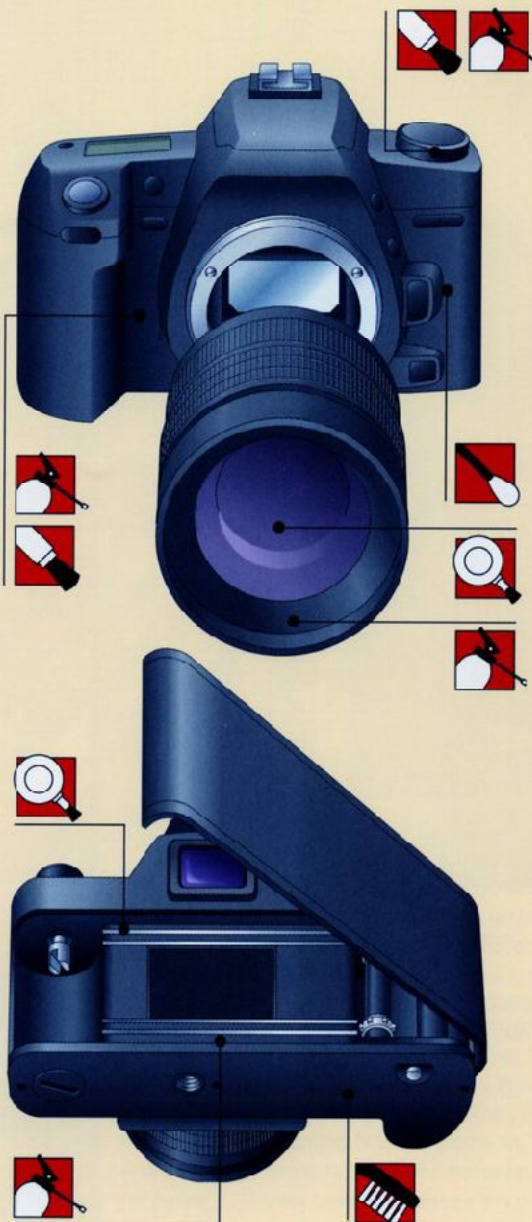

### CAMERA MAINTENANCE

If dust or sand has penetrated your camera, stop using it immediately. Once particles are inside they will go deeper and do more damage if you continue turning the controls. Remove the film and dismantle the body as far as possible. Use compressed air to remove particles from all delicate and inaccessible parts. Brush the rest away with a blower brush and then wipe with a clean cloth. The exterior of a camera body, however, can be treated firmly. Use a toothbrush to remove stubborn dirt and moistened cotton swabs to reach awkward corners on the exterior of the camera. The diagrams (left and below left) show which pieces of cleaning equipment you should use on the different parts of your camera. The key to the symbols is shown below.

#### KEY

-  Compressed air
-  Stiff toothbrush
-  Blower brush
-  Cotton swabs
-  Stiff brush

**SHOOTING TOWARD THE BEACH**

Glamour photographers like working on beaches, because there is such a variety of elements to exploit. By shooting from the sea toward the beach (far right) the photographer can make use of the luxuriant greenery as a background. Light reflected off the surface of the sea can be used to bring up the exposure. The picture above shows how the shot was taken. A portable reflector is being held by an assistant to throw side light onto the model. The photographer had to wade up to his neck in water.



The picture above shows how the shot was taken. A portable reflector is being held by an assistant to throw side light onto the model. The photographer had to wade up to his neck in water.

85mm lens, Kodachrome 25, 1/125th sec, f16



**SHOOTING TOWARD THE SEA**

By shooting toward the sea from the beach the photographer gives himself the chance of using the blue background that it provides (left). The rocks add another point of interest along the horizon forming a strong line across the image and echoing the rock that the model is sitting on. Care should be taken with sand, however, as it gets everywhere. If you want the model to lie down, remember that sand will adhere to her skin, and that she will then have to go in the water to clean it off—and when she emerges wet, more sand will attach to her. The solution is to plan the shoot carefully. Sand also has a habit of getting into the cameras. It will scratch the finely polished surfaces of lenses and jam the film transport mechanisms unless particular care is taken.

50mm lens, Kodachrome 25, 1/250th sec, f8



**SHOOTING IN THE WATER**

If you want to shoot from a position in the water (right), you must keep the camera dry—the last thing you need is a rusty camera. Droplets on the lens will dry leaving a ring of salt deposit on the front element. The best solution is waterproof housing, or, if your budget doesn't stretch that far, to wrap your camera in a plastic bag (left) with only the front of the lens peeping out. It is best to use a power winder or a motor drive to transport the film.

127mm lens, Kodachrome 64, 1/125th sec, f5.6





property, you will have to go through the correct channels.

Once the photographer has found the interior he is looking for, he must ensure that the owner is aware of the nature of the project, and that the normal running of the place is interrupted to the minimum degree. At the first approach, the owner is quite likely to turn the request down.

Be prepared to pay him. Owners of beautiful properties need money for their upkeep, and that is the most straightforward way around the problem. Offer what you think is a reasonable sum and be prepared to haggle.

Point out the advantages of cash payment and reassure the owner that the property will not be damaged in any way and that it

will be left in precisely the condition it was found.

Explain which rooms you want to use and for how long. Your team will feel much happier if there are no strangers around when the shooting is taking place so, by being tactful and reassuring, do your best to persuade the owner to leave the shoot while it is actually in progress. Even if the

*When using a property, check where and when the sun will be in relation to windows and balconies so that you can use it to good effect.*  
50mm lens, Kodachrome 25,  
1/125th sec, f8





owner does not charge you for the use of the property, you must explain to him that you will have to use electricity. You will also need the use of a changing room, a toilet, and somewhere to park

When you are researching locations, make certain that all the necessary facilities are available. Make a list of what you need and methodically check all the items as you go. As well as the basic facilities listed in the last paragraph, note whether the sun shines through any of the windows during the day. Take pictures of the location while you are there; it will help you to assess the property's possibilities when making your final choice. There may be special requirements for the particular pictures you want to shoot. If, for example, you need to include hot food in the picture, you will need a kitchen that is not being used by anyone else. On one occasion a photographer wanted to set up a banquet scene. He found a marvelous room in a run-down country house. On the appointed day he turned up with half a dozen models and a team of assistants. The girls who were to prepare the food went in search of the kitchen, but to their horror found only a dilapidated stone sink with no running water. It was an expensive oversight on the photographer's part.

*With interior locations it is best that the model has some relation to her surroundings. This means that the picture attains the illusion of a narrative. The relationship between the model and the location should be one either of contrast or harmony. For example, this picture, shot by Bryon Newman, shows a model whose clothes are in disarray posing in an environment that emanates good taste, orderliness, and refined behavior: the staircase of a stately home. The contrast adds a freshness to the image, and a sense of intrigue to the picture, thereby provoking the viewer's curiosity.*  
28mm lens, Kodachrome 64, 1/8th sec, f8

Unoccupied properties have their advantages. You are almost certain to have the run of the place with no outside interruptions and you can generally change the fixtures and fittings as much as you like. But do check carefully that you have brought all that you need. You probably will not find any electricity, for example. That means you will have to rent a small generator to power your lights. You will also probably need to have a base somewhere else, such as a nearby bar or hotel. Another point to remember is that the local police should be alerted that you will be working, otherwise they are quite likely to come and investigate what is going on.

James Wedge, a London-based photographer, recalls an occasion when he took over a derelict house to shoot some fashion pictures for a Sunday newspaper. The art director wanted the house to look as though it was on fire, so the props man set up dry-ice canisters and red flashing lights inside the house to simulate smoke and fire. The idea was that the models would then lean out of the windows and Wedge could photograph them. All went well, until two fire engines came screaming round the corner. Apparently someone had reported the fire. The firemen were not amused.

If your pictures are intended to have a period flavor, you must pay particular attention to detail. It only takes one electric light-switch in the background to spoil a shot that is supposed to be set in the eighteenth century. Radiators, light fittings, and out-of-period furniture crop up too frequently in what are supposed to be period interiors. They may sound obvious but the number of times that details like this are overlooked while the shoot is in progress is surprising.

The best way to avoid all these traps is to plan the shoot meticulously. When you are hunting for your location, take your rough along and compare it minutely with any likely places. Consider as well whether you will have to change the whole concept of your picture to accommodate the demands of the location, and then check that these changes do not have repercussions that will adversely affect the final result that you are seeking.

Once you know that the picture can be shot there, turn your attention to the wider aspects of the project. Will you and your team be able to work comfortably and efficiently at the location? Are all the necessary facilities available nearby? If something goes wrong, will it be easy to contact people who can help? Are there shops nearby that will be open in case you have to make last-minute purchases? Is everyone who might be remotely affected by your presence aware of what is going on? If the answer is no to any of these questions, think twice before setting off to shoot. Bad organization will only inevitably add to the multiple problems that can arise while shooting on location. The best way to avoid this is to check everything very carefully before starting to shoot.





*(Above) Don't be afraid to let a little humor enter your work.*

*Sometimes a location can generate ideas that are too good to resist!*

80mm lens, Fuji Provia, 1/125th sec, f8

*(Right) When shooting inside a building, make use of natural light coming through windows.*

50mm lens, Kodachrome 25, 1/125th sec, f5.6

## IMPROVIZED LOCATIONS

The photographer who cannot afford to travel to exotic and far-off places can still discover beautiful and unusual locations nearer home. He can also, with the imaginative use of props, costumes, and light, transform commonplace surroundings into a good setting for a picture.

One London professional was commissioned by the tourist board of a Caribbean island to shoot a poster showing a girl posing on a tropical beach with a windsurfer in the background, but their budget did not cover the expense of a shoot taking place in any tropical country.

Having given the project some thought, the photographer

decided that he had no need to go further than the South Coast of England to take an effective shot. The picture was composed with the girl occupying half of the frame, her head tilted back as if she was catching the sun's rays. A potted plant was then strategically placed so that its fronds extended beyond the model, and the windsurfer was asked to sail around in a particular area in the background.

The photographer shot the picture into the sun so that flare obscured much of the upper part of the frame. This made it look as though the picture had been taken under strong tropical sunlight. A polarizing filter was then used to make the sea a richer blue which contrasted nicely with the bright red of the windsurfer's sails.



**COMPOSITE IMAGES**

*The modern equivalent of a hand-painted photo, this picture is a digital composite where the model was shot on location for a different shoot, then cut out and used with wooden textures to create the main image. Once the composite had been created, it was desaturated and then hand-colored using Photoshop.*

Fuji S1 Pro digital, ISO 320, 1/8th sec, f2.8

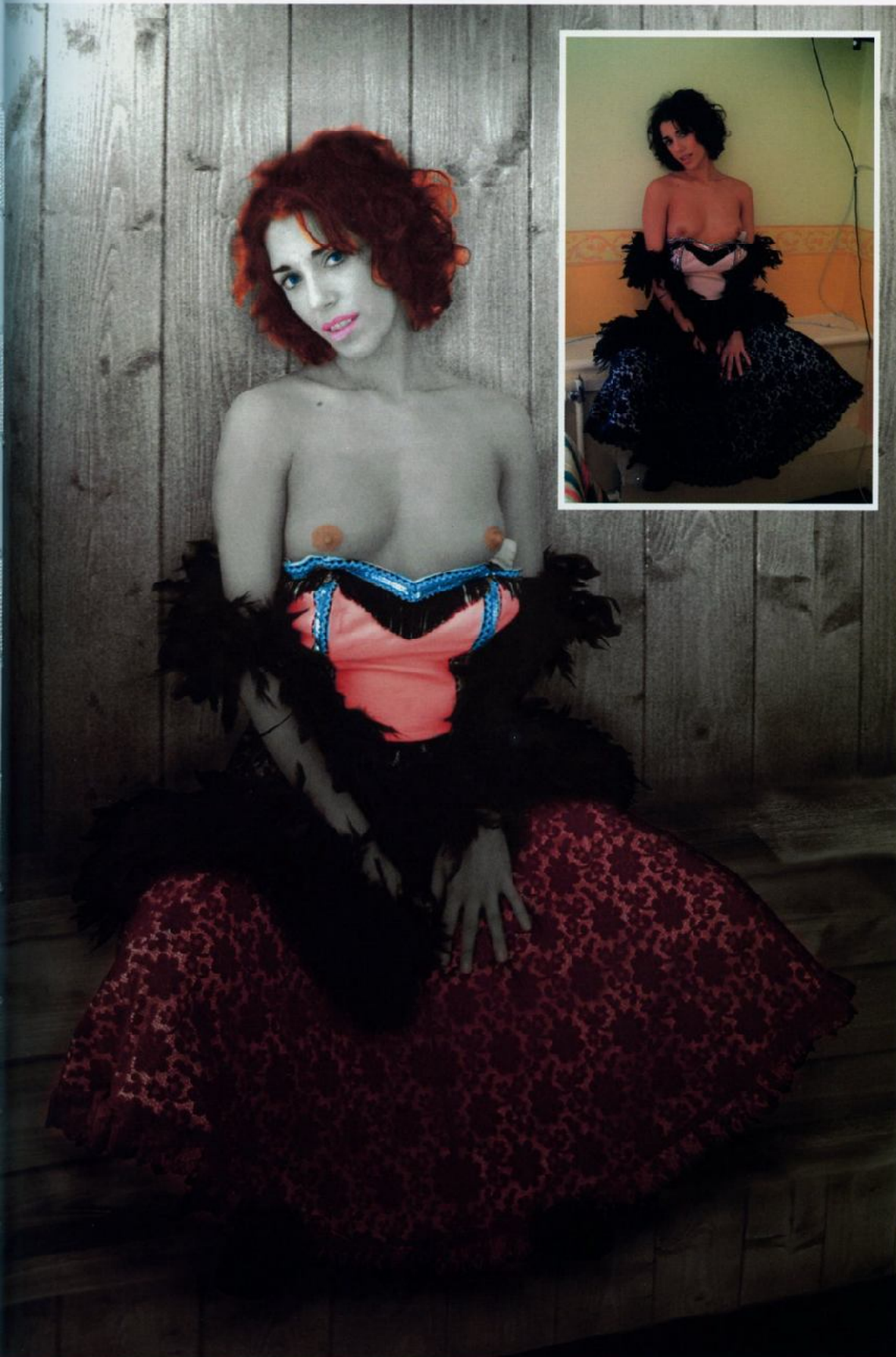

# COMPOSITION

Every photograph consists of a variety of elements. The skill of a photographer lies in his ability to manipulate these elements to procure a fresh and striking image. In order to do this successfully, the photographer must be able to recognize the visual potential of the various factors at his disposal and acquire an understanding of how to make use of them.

## COMPOSING THE IMAGE

Every successful picture has a point of maximum interest, to which every other element in the picture is of secondary importance. When planning a shot, this focal point must be decided at an early stage. The rest of the picture can then be designed around it, so that each element contributes harmoniously.

To achieve this effect, it is essential that the photographer is aware of the impact value of each element. In glamour photography a human figure attracts greater attention than an inanimate object. A face takes precedence over a body. Of all the facial features, it is the eyes that first catch the viewer's attention.

Shape and color are also prime attractors of attention. A vivid red ball takes visual precedence over a pastel-colored one. Stark, well-defined shapes stand out strongly, while amorphous, irregular patterns make less demands on the viewer. Sometimes, of course, the

photographer may wish to produce a soft, misty effect and allow gentle, blurred images to become the center of interest in the picture. This effect can be achieved by diffusing the light as it enters the lens. The soft edges created by this technique help to give the shot a romantic feel.

There are various ways of achieving this sort of diffusion. In the past you might have seen photographers smearing a little Vaseline on the lens, taping a piece of nylon stocking over the front element, or spending a lot of money on a special lens that was designed to blur the image. Fortunately nowadays the common practice is to use a filter system, from companies such as Cokin, that screws to the front thread of the lens. These filters are cheap, durable, and effective. It is even easier for the digital photographer because the diffusion can be added painlessly using Photoshop later.

## VIEWPOINT

One of the features of a good photographer is an ability to present an unremarkable subject in a fresh and arresting way. When you consider that we are accustomed to seeing the world from a height of 5–6 ft (about 2m) above the ground, it is not difficult to realize that by raising or lowering the camera, an unusual viewpoint will be produced. This fact applies to all forms of photography, and glamour is no exception.

*This picture makes good use of composition. Note the way the model's leg follows the angle of the rocks, yet her upright sitting position draws the eye to the center of the image. A wide aperture also throws the background out of focus.*

150mm lens, Kodachrome 25, 1/250th sec, f5.6

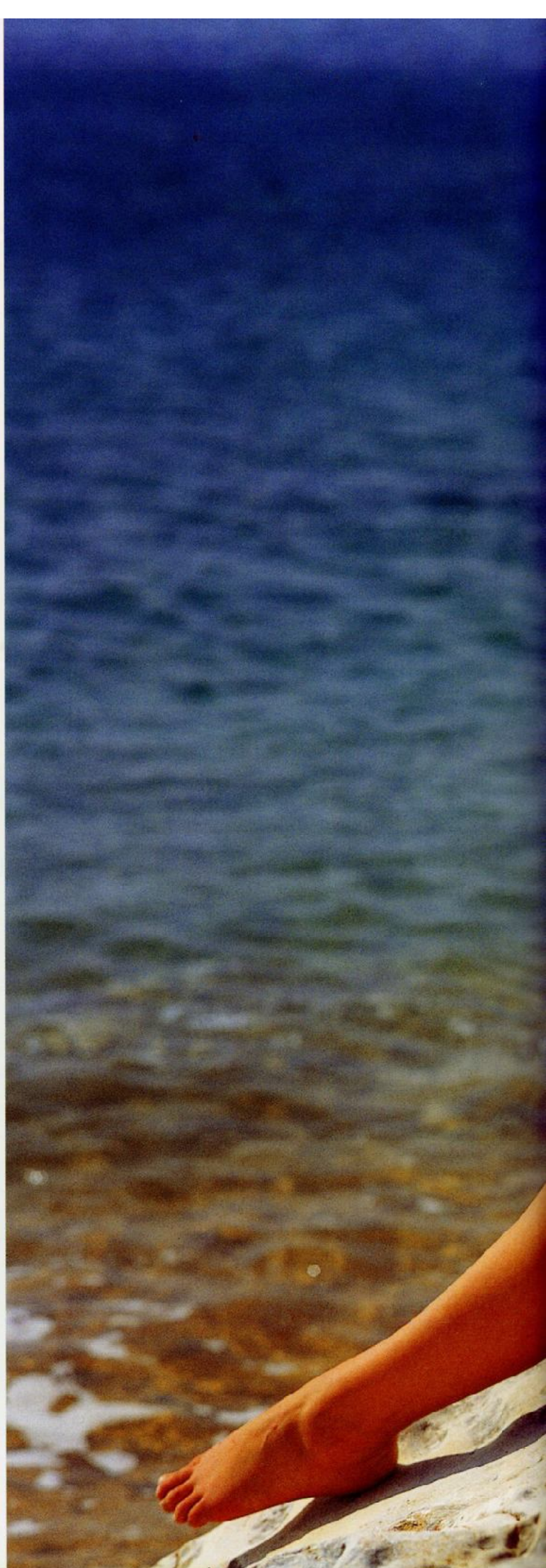







*(Left) An unexpected viewpoint can boost the appeal of a picture enormously. We are accustomed to seeing the world from a height of 5–6 ft (about 2m). When we see a view from any other angle it strikes us as novel. The bird's-eye angle of view has produced order in a picture that would have been messy, had it been shot from head height. The high viewpoint also brings about a change in the psychological effect of our perception. Because we are above the model, there is a sense of voyeurism. The subject is defenseless and vulnerable.*

40mm lens, Ektachrome 64, 1/125th sec, f16

*(Above) In contrast, this picture is taken from a low viewpoint. The model is looking down at the camera with a menacing air.*

135mm lens, Kodachrome 64, 1/125th sec, f5.6

An example of this is the aerial photograph. However well you know the front, back, and sides of your own house, it is unlikely that you have seen it from above. The change in viewpoint helps to make a picture of the house interesting and different by showing a new dimension.

It should also be noted that changing the viewpoint affects the subject's impact value. A low viewpoint, with the camera at floor level pointing up toward the model, will make her dominating and overwhelming, whereas a high viewpoint, looking down on the subject, creates a more vulnerable impression.

## **BACKGROUNDS AND FOREGROUNDS**

It is essential that the photographer pays attention to what is behind and in front of the model if she is to stand out as

the focal point of the picture. Backgrounds can be used to add atmosphere to a picture, or they can be an integral part of the composition. Conversely, they can be largely eliminated or at least toned down. The choice of a low viewpoint when photographing a model on location will often give you a background of sky, a single tone that will set off the model without attracting attention to itself. If you are forced to shoot the model against a fussy background, you can tone down the distraction by using a wide aperture on the camera and bringing your model as near to the camera as possible. The background will then be thrown out of focus and reduced to a blur.

Foregrounds can also be used to enhance a picture, but they require more care on the part of the photographer. The danger is that anything positioned between

the camera and the model will tend to distract attention away from the main point of interest. Provided you remember that foreground details must lead the viewer's eye back to the model, you can use them to good effect. Branches, for example, can form a frame around the model's face. Differential focusing can also be used to keep the model in sharp focus between blurred foreground and background.

## **USING LOCATIONS**

Successful glamour photography depends largely on the photographer creating a sense of harmony between the model and her surroundings. If a single discordant element creeps into the composition, the overall effect of the picture is significantly reduced.

It is not surprising that many photographers choose to shoot



(Above) A sense of harmony must be maintained if a composition is to work well on film. The scarecrow model perfectly suits her rustic surroundings. The fact that she is standing in a prominent position on a hill adds to the credibility of the picture. Note also that she is posed one-third of the way across the frame, a position that allows her to be the main point of interest while still leaving a clear view of the beautiful landscape. There are two strong horizontals in the shot—the skyline and the model's outstretched arms. The eye is naturally drawn to the area defined by those horizontals, and is therefore led to the model's torso. 24mm lens, Kodachrome 64, 1/125th sec, f8



(Right) In this picture the model's arms form a natural frame, while the water pistol protrudes from the frame as if to guard its contents. 50mm lens, Ektachrome 64, 1/125th sec, f16



*(Left) It is widely accepted that a scantily dressed model is far more attractive than one with no clothes on at all. In this picture the photographer has dressed the model in skimpy clothes and then asked her to make the clothes wet, thereby producing a clingy effect that is much in demand by buyers of calendar pictures. 85mm lens, Kodachrome 25, 1/125th sec, f5.6*

glamour pictures by the sea, in the sun. A nude or semi-nude model posed on a beach fits in easily and happily with her surroundings and a harmonious effect is created. A similar impression would not be achieved if a scantily clad model was posed on an ice floe.

Beaches have other properties that make them ideal for glamour photography. They offer the photographer plenty of room in which to work. He can set up all his equipment and still shoot out to sea, along the beach, or toward the land. The sky, the sea, and the sand are single-tone elements, and he can rely on his model being the dominant interest in the picture if he limits

himself to including only one background tone.

He can also exploit the natural abundance of textures found in a beach setting. The combination of smooth skin and sand, for example, can help to provide a vital element in the composition of a picture.

Water offers the photographer all sorts of possibilities for pictures. It can be used simply as a visual backdrop. It can vary or improve the tonal qualities of a shot thanks to its chameleon-like capacity to change color according to the state of the sky. It can also help to create and change the atmosphere of a picture. The glamour

photographer can effectively use a calm sea to complement a romantic picture. Alternatively, choppy waves suit a lively picture of a laughing model in bright sunshine playing in the sea.

The sensual quality of water has equally attracted photographers. An expanse of tanned, smooth skin, dotted with droplets of water is a cliché, but it is an effective one.

Landscapes, if carefully selected and composed, can also form a suitable background for glamour photography. For example, the gentle undulations in a landscape set off the soft curves of a female body. In order for the model to fit naturally into her surroundings,

the photographer must look for shapes and colors that harmonize, or contrast, in order to give the picture the correct emphasis, and leave the model as the centerpiece.

## **CLOTHES AND PROPS**

Asking a completely nude model to pose is a recipe for disaster, therefore some direction is essential. Clothes and props can also be of great help and even if you intend to take nude pictures it is usually better to start off with some shots of the model fully dressed. The beginning of the session will go more smoothly if she is relaxed and as the session progresses she will feel happier about undressing.



WORKING PROFESSIONALLY

*(Right) Working on a leg/shoe fetish level, you cannot see most of the model and there is no nudity, yet it still has plenty of impact.*  
80mm lens, Kodachrome 64, 1/125th sec, f8

*(Below) A simple pose is maximized by asking the model to stare at the camera—this produces questions in the viewer's mind making it an effective image.*  
50mm lens, Kodachrome 64, 1/125th sec, f11





Modeling is said to be similar to silent acting. Clothes will help the model to enter into the mood of the shot. If, for example, you want your model to play a vampish part it will be easier for her if she has an appropriate costume to wear. Similarly, if you want her to look sullen and aggressive, ask her to dress in leather or suede. It is worth remembering that female models are often far more aware than men of the effect that clothes can have. Provided that you have briefed your model on the sort of effect you want to achieve, the chances are that she will know how to implement the look.

Professional models keep extensive wardrobes of clothes which you should try to go through with them before the session. You will often find that the clothes themselves give you ideas for pictures. However, if the model does not possess the sort of clothes you need, you could try asking a local boutique if they will lend you some clothes for the shoot, in return for a set of pictures. Don't waste your time asking high street brand-name stores though, because they will have a limited amount of "review stock" and this is all supplied to the fashion press at the start of a new season.

Clothes and jewelry can direct the viewer's attention to areas you wish to emphasize. For

example, a pretty necklace can help to make a fine neck the focal point of the picture. Clothes, such as blouses and scarves, can mask parts of the body and soften the blatancy of a nude shot, providing possibilities of tantalizing and erotic pictures. Props fulfil much the same role as clothes. A good prop can set the tone for an entire session. The model will be much happier if she has something to react to. She will be able to improvise around the prop and you can allow her imagination to do some of the work for you.

When choosing a prop, make sure it has a value of its own and that it adds something—color, shape, spectacle—to the end result.

### ABSTRACT SHAPES

Photography is a graphic medium and therefore many tricks employed by designers can be used to add zest to an image.

If, for example, there are any lines included in the picture area, the photographer should ask himself whether they are adding to, or subtracting from, the impact of the image. As a general rule, lines should lead the viewer's attention toward the center of interest, which is usually possible by altering the camera angle. It is sometimes possible to create a frame within a frame, such as a model glimpsed through a



*(Above left) The impact of this shot comes from the hosiery, the position of the legs, and the sharp contrasts of color.*

80mm lens, Kodachrome 64, 1/125th sec, f16

*(Left) In this retro-styled shot, the clothes and props are all designed to be bright and reflective and the model's expression and pose are provocative.*

50mm lens, Kodachrome 25, 1/125th sec, f4



window or in a mirror. By including the frame itself the image has two frames, each one bringing the viewer further in toward the picture's focal point.

The bolder the lines in the picture the more care must be taken to ensure that they contribute to the effect you are trying to create. This applies also to strong areas of tone or shape that can unbalance the composition. Unless the photographer is aware of the dynamics of his image, it is quite possible to find that an essentially irrelevant area of the

picture takes precedence over the principal subject.

Texture can also enhance a shot. To bring this out, the photographer must ensure that the material in question is lit strongly from the side. A rough texture, such as stone, contrasts well with smooth skin, adding emphasis to the tactile qualities of both.

These graphic devices work particularly well with abstract glamour. By photographing only a portion of the model's body, the

photographer can depersonalize the image and reduce it to abstract shapes. This often introduces an element of mystery into the picture. By removing the image from our everyday concept of the nude the photographer can produce an exciting and challenging shot for the viewer.

This approach has particular advantages for the hobby photographer, particularly if he is using his partner or a friend. Since he need not show the model's face she is likely to be more at ease during the shoot,

knowing that there is little chance of anyone connecting her with the image. The reduction to a series of shapes also means that the photographer can play tricks with the priorities of the image. As there is no human face to demand the viewer's attention, and the body becomes simply another abstract, the photographer can invest other elements in the picture with a greater degree of importance.



*(Above) Strong images are created through the use of bold colors and striking patterns, regardless of the actual subject matter. This apparently casual picture was in fact carefully staged. The colors of the sunbeds and the model's bikinis were selected specially to contrast with each other. The girls were asked to lie in a particular position so that their forms all matched. A high viewpoint was chosen so that the photographer could eliminate the sides of the swimming pool to leave only the pure blue of the pool itself as a backdrop.*  
85mm lens, Kodachrome 64, 1/250th sec, f5.6

*(Right) This picture is a simple study in shapes. Use of the wide-angle lens produced an elongated effect that increases the apparent size of the telephone in relation to the model.*

18mm lens, Kodachrome 64, 1/250th sec, f11

*(Below) By placing the model under a diffuser screen and selecting a high viewpoint the photographer found a way of showing only the shape of her body.*  
90mm lens, Ektachrome 64, 1/125th sec, f16

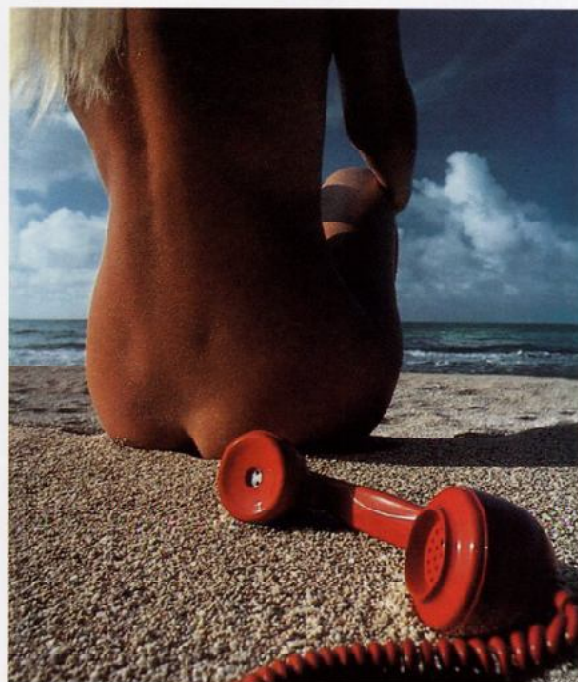

## THE MODEL

In the final analysis, glamour photography is not about cameras, lighting, and film—it is about capturing the essence of female beauty. It is a visual attempt to define what makes a woman attractive. The photographer produces images that may, or may not, capture a certain characteristic, mood, or look that appeals to the viewer. Since beauty is purely subjective, it is likely that only a few pictures will really create an impact on any one viewer, which perhaps partly explains why the demand for pictures of attractive women continues unabated.

### **MODEL/ PHOTOGRAPHER RELATIONSHIP**

To present female beauty successfully, it is not simply a question of finding a girl who has fashionable vital statistics, is of the right age, and has the right haircut or style. The elusive element springs from the model's personality. If a girl is naturally quiet and withdrawn, the photographer should work to make the picture show this aspect of her character. Likewise, a lively and effervescent girl should be photographed in a situation that allows her to be herself. Newcomers to glamour photography often overlook this vital fact and find that the session is stilted and awkward as a result. Any tension between the photographer and the model will almost always show in the final shots.

Professional photographers talk about establishing a rapport with a model—probably the most crucial element in any glamour session. What they mean is that they take the trouble to get to know the model's personality and are not simply preoccupied with her surface appearance. This, of course, takes time, which explains why so many

professionals only use a small number of girls. The better the relationship you can establish with a model the more likely it is that she will be relaxed and that the camera will pick up that indefinable quality that turns an ordinary picture into a special one.

The rapport which a photographer can establish with a model is helpful whether he is taking fashion pictures or portraits; it is even more important if the session is to be either nude or semi-nude. Nakedness promotes a feeling of defenselessness and vulnerability and it is up to the photographer to make the model feel relaxed and comfortable in front of the camera. There are certain practical considerations that should be dealt with by the photographer. The immediate environment should be private and there should be no chance of intrusion by strangers. It must also be comfortably warm. If the shoot is indoors, music often helps to provide a relaxing atmosphere. The radio is an ideal device to use because the music will be broken by the DJ speaking, which introduces another voice into the room and dispels any feelings of isolation.

One of the most effective ways of distracting the model's mind from the unaccustomed role of appearing naked in front of other people is to construct the shot so that she has something positive to do as part of it. She is soon likely to stop feeling self-conscious about her nudity if she is able to concentrate on something else. It is at this point that props and the nature of the setting come into their own. If the photographer gives the model a book, for example, she can experiment with different ways of holding it. The task will use her acting skills which are a necessary part of good modeling. The best approach is to explain





*This casual, relaxed shot was not planned. It was taken at the end of the day and acts as a happy memento of a successful day's shooting.*  
35mm lens, Kodachrome 64, 1/250th sec, f8

to the model clearly and precisely what the pictures are for, her role in the series of photos you are to take, and the kind of expressions and posture ranges that you want to encompass. Answer any questions and ensure that the model is on the same wavelength. By doing this you will involve her much more fully than just giving her a book and asking her to pose with it. When the shooting then starts you can move the model from pose to pose with the minimum of deliberation, which keeps the flow of the creative process going. If you have to stop for every shot to explain exactly how the model has to look, over and over again, she will get bored

and frustrated, you will become short tempered and agitated, and the shots will reflect it. So plan beforehand and explain fully before you begin.

### ASSESSING A MODEL

Other aspects of a photographer's relationship with his model are also important if a session is to be successful. As a craftsman, the photographer must be able to assess a model's

body and face critically. There is no such thing as the perfect shape. Every figure has merits and faults but it is up to the photographer to draw out the model's best attributes.

A model's hair can be dressed in any number of styles, given time. If, for example, you are planning a period picture, it might be appropriate to have the model's hair in ringlets. There is no point in telling her this five minutes

### TEST SHOTS

*At the beginning of a session, a series of test shots is a good idea. The results are often surprisingly good (below). The shots can help the model to relax and provide a good basis for a working relationship. They also give the photographer valuable information about the model's good and bad points.*



### DESIRABLE ATTRIBUTES

*Study your model carefully before you start shooting. Note her particular strengths so that you can emphasize her good attributes, while disguising any imperfections. Listed below are some of the points to consider when assessing a model.*

**Height** For nude photography height is unimportant, although the body should be well proportioned.

**Hair** Healthy, shining hair is very important.

**Skin** A clear skin is very desirable, although blemishes can, of course, be disguised with careful makeup.

**Face** A profile shot might suit your model's face better than a face-on one.

**Neck** If your model has a long, thin neck, make the most of it. It can look very elegant in a picture.

**Bust** Size is very much a matter of taste—firmness is generally more important than the size of the breasts.

**Waist** A small waist is preferable, but not essential. But the waist should be in proportion to the hips and shoulders.

**Hands** If your model has long, fine hands make the most of them. Watch out for noticeable veins in the hands.

**Hips** Wait for pressure from underclothes to disappear.

**Long legs** These are a great advantage in glamour photography. However, if your model has short legs you can compensate by shooting from a low viewpoint to make the model's legs look longer.

**Specialist training** Check with your model to see if she has any training that can be utilized. The girl featured opposite revealed that she was proficient in ballet and subsequently her pose made use of this fact.





before the shoot is scheduled to begin. However if you let her know in plenty of time she will be able to do something about it. You should also remember, when assessing a potential model, that a hairstyle that does not belong in the shot can be eliminated either by framing closely on the girl's face, or by asking her to wear a wig.

Unless you plan to shoot an abstract nude that does not include the model's face, you must pay attention to the model's head. No one has yet produced a formula that will tell you whether a model will be photogenic or not, but the general rule is that strong, well-defined bone structure will produce the best results on film. Soft, round faces can look homely. Sharp, pinched faces can look hard. The ideal lies somewhere between the two, but it is probably wiser to err on the thin side.

There is a simple photographic reason for this. The bone structure of a face defines its different areas sharply. By throwing light onto it from different angles each area is illuminated in turn. It is therefore possible for the photographer to build up a clear view of where the contrasting tones of light and dark will fall in the final picture. However you light a round face, the contrast will blur gradually from light to dark, and there will be none of the definition lines that delineate the bone structure.

Study the girl's face carefully and look for blemishes. They may be scars, wrinkles, birthmarks, even a crooked nose. All these things can be disguised by careful lighting, but it always helps to know with what you are dealing. One area that is often overlooked is the teeth. Make sure that the gap between the front teeth is not too wide. It may sound petty, but a black gap in a set of gleaming white teeth is very noticeable. Do not be overly

concerned about any minor blemishes, especially when working with amateur or semi-pro models because the results can always be retouched later. This is easier for the digital photographer because the photos are already in a computer-friendly format, but for film users it means having the slides scanned, either by yourself, or if it is for a commercial concern, having it scanned professionally.

What constitutes a good figure is a matter of fashion. The painter Rubens evidently thought that plump curves and full breasts added another dimension to a model's level of attractiveness. In the 60s it was the thin and slender look, in the 80s the curvy big breast look was popular, the 90s saw skeletally thin models, and now we are back to girls who are fit and healthy, but often with breast implants. No one wants to see overweight models with large swinging breasts though. One successful London glamour photographer always recruits his models from the ranks of dance choruses. He maintains that they are exceptionally fit, their muscle tone is perfect without a hint of sag or droop, and they are accustomed to very hard work. This is a good description of a successful glamour model, especially as a girl's figure is probably at its best for modeling purposes in her late teens.

## POSING

The traditional image of the photographer posing his model in carefully-staged attitudes is misleading. There was a time when the photographer instructed his models to stand in a certain way and remain absolutely still until the picture was taken. That was in the days of slow film, when the shutter had to remain open for anything up to a minute. Any movement would have recorded as a blur and the effect would have been ruined.

Fast-film emulsions have virtually put an end to static posing. The model can move around and, provided the photographer uses a shutter speed of 1/500th of a second, the pictures should be reasonably sharp.

This is just as well because there is little models loathe more than striking and holding a frozen pose. It is almost impossible for her to keep a happy expression looking natural after spending an hour or so with a fixed smile on her face. A spontaneous look of delight is far more appealing.

This is not to say that the photographer should not be fully aware of the effects of certain body postures or that he should not ask the model to adopt them at times.

The first and most important rule of glamour posture is to make sure that the model looks proud of her figure. If she is standing, she should try to keep her back straight, her chest out, and stomach held in. The last thing you want is a model who is hunched up, as though she does not really want to be in the picture at all. The shoulders are also important. The model should keep them back if her arms are in

front, and forward if her arms are behind. Rules, as was said earlier, are made to be broken, but only if you are sure that the effect is pleasing.

The least attractive angle from which to photograph a model is square on. This always looks posed and stagey. Always try to position your model at an oblique angle to the camera. This will help to show off her figure and add a touch of dynamism to the picture.

What you have to ask yourself is what is the image and mood you are trying to convey. If the scene is a country house, with the model dressed in expensive underwear and jewelry, then you do not want her running about grinning like a lunatic. A studied and elegant pose is required. Alternatively, when capturing your model frolicking on the beach, splashing in the water, you want lots of action and big delighted smiles, not someone pouting. When doing an action-packed shoot the onus is on the photographer to work quickly enough to keep up with the rhythm of her movements. This method entails shooting a great deal of film, much of which is unusable because the model is

## MEMORY CARDS

*The essential accessory for digital photographers is the memory card. Unlike film, it can be used and re-used, and with some of the larger memory cards, over 100 pictures can be stored at any one time. This means that there will be no waste when shooting a model.*





**CAREFUL POSING**

*Who could guess that the model's dress (right) is being kept together by pieces of sticky tape and a bulldog clip? During a break between shots, the model studies Polaroids of herself (above) and considers how she can improve her pose. This pose is based on an airbrush illustration by Vargas (above right). A great deal of care and concentration are needed on the part of the model and the photographer to get a re-creation right. In this shot, it is remarkably successful.*





**BEFORE AND AFTER**

Even the most ordinary face can be made to look stunning with the correct application of makeup to emphasize her strengths and cover or detract from any weaknesses.



blurred or blinking, but it will almost certainly produce one or two shots that have punch and impact. If shooting digitally then of course there is no waste because you can simply delete the unusable photos from the memory card and re-use it.

The art of making a model look attractive depends to a huge extent on the photographer's ability to pinpoint what it is about the girl that makes her appealing. One model may have devastating eyes, while another's strong point may be long legs. It is no good exposing hundreds of pictures of a particular model just because she is good-looking. You must have a firm idea about the reasons for her appeal and pinpoint this in your shots. More pointedly, back at the planning stage, you should have an idea about what the mood and concept of the shoot is and hire a model whose physical characteristics fit that picture.

**FEATURES TO EMPHASIZE**

**Lips** Lip coloring helps you to achieve the effect you have in mind. For example, if you want the girl to look sexy, try a deep glossy red and ask her to make her lips look as full as possible. If, on the other hand, you want the fresh innocent look, a light pink may be appropriate. Lips can be reshaped with the clever application of lipstick and lipliner. The illustrations show how to correct a wide (1), a full (2), a thin (3) mouth.

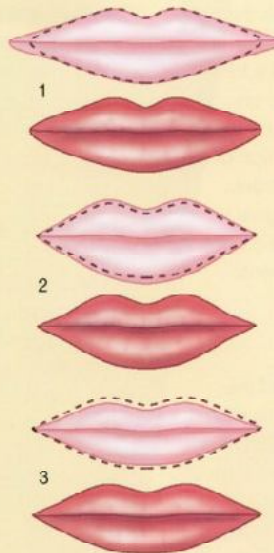

It is then possible to assess how to make the most of the model's attributes. It would be idiotic to ask a girl with beautiful eyes to wear a pair of sunglasses. But the correct emphasis may be achieved by getting her to look directly at the camera while holding a pair of sunglasses, as though she has just raised them up to get a better look at the camera. The viewer will think that the model has been interested enough in him to raise her sunglasses. There is also the suggestion that the revelation of these beautiful eyes is a rare occurrence, as they are usually masked by the sunglasses.

A more obvious example is the long-limbed model. It would be quite possible to photograph her sitting at a table, sipping a drink. The shot might be perfectly exposed, exquisitely composed, and visually altogether stunning. But the photographer would be failing to make the most of his opportunities, simply because he

**Eyebrows** The eyebrows play an important part in characterizing the face. Care should therefore be taken to ensure that they are correctly plucked and shaped. They can be tidied up by brushing the hair in one direction, and, if necessary, an eyebrow pencil can be used to fill in the shape.



has masked the model's most outstanding feature. Far better, for example, to have her standing full-length against a balcony with the setting sun behind her as she sips her drink.

Choose the clothes that you want the model to wear with great care. Make sure that they suit her skin or hair coloring and that they harmonize or contrast with any background colors you intend to keep in the shot. Hats can be useful, particularly if you are shooting in strong sunlight. Chosen with care they can add a great deal to the style of the shot, although avoid any hats that are too formal; many professionals prefer caps or possibly men's hats.



### MAKEUP

The picture above shows a basic selection of cosmetics and makeup equipment. It includes: lipliner, lip gloss, lipsticks, eyeliners, eyeshadows, blusher, mascara, eyedrops, face powder, foundation, eye-makeup remover, toner, and cleanser. A selection of different-sized brushes is also useful. Although models do have their own makeup, it is worth keeping an emergency stock in case they forget or run out of something.



### BODY MAKEUP

Body makeup is frequently used in glamour photography; it has two functions—to decorate and to disguise. As decoration it may take the form of exotic designs painted onto the model's body, giving a tattoo-like effect. As a disguise, it can be used to cover birthmarks and blemishes that would otherwise spoil the effect the photographer is trying to achieve. If you wish to create an extreme effect and make it look as if the model's body is completely painted it is still essential to leave a strip down the spine of the back clear so that the pores can breathe properly. In the picture (left) a type of spray-on body makeup was used to achieve this silver, metallic effect and the model has also tinted her hair. The effect the photographer was striving for was that of a metallic sculpture.

# POST PRODUCTION

Once the shooting session is over, the films must be sent for processing, unless the work is digital, in which case post production can start immediately. However, film-based professional photographers tend to use a laboratory that they know and trust for all their processing work. Consistently good results in the past reduce the anxiety often felt between shooting and receiving the processed images.

If you are in any doubt about the exposure levels on a particular film, you can ask the laboratory to perform a clip-test. This involves cutting a frame or two off the beginning of the film and processing them normally. If they show consistent underexposure, the rest of the film can be processed for slightly longer than normal and the slight deviation can be rectified.

It is worth bearing in mind that the stated ISO rating of any film is nominal. Manufacturer's quality control allows a variation of a third of a stop. Professional photographers usually buy their film in bulk and make sure that each roll is from the same batch. They then expose a roll and have it processed carefully. A consistent variation of the exposure index shows them that the film is either over- or underrated. The variation can be allowed for whenever film from that batch is in use.

If you have rated the film over or under its nominal ISO speed while shooting, perhaps to overcome low light levels, you must tell the laboratory. They can then "push" or "pull" the film to compensate for the difference.

If you have used reversal film it is preferable to have the roll returned to you as strips, rather than framed. There is always a certain amount of wastage, particularly if you have bracketed

your exposures, so there is no point having useless pictures mounted. It is standard practice to have medium-format 120-roll film returned as strips, from which the selected photos can then be cut out.

## DIGITAL CORRECTION

In our age of computers, all commercial film work is scanned into a digital format for use in production. If you have your negatives scanned on a professional drum scanner then you will be able to make any corrections to images yourself, but it is more likely that the client's production people will do this for you. Therefore you need to ensure the original is as good as possible. Digital is more flexible because the camera output can be directly transferred to your own computer. From there, teeth and eyes can be whitened, and pimples, spots, and blemishes removed. Skilful Photoshop users can also change the texture of the model's skin if required, giving it a subtle, film-star-like glow. Aside from minor retouching, the obvious



## PROJECTORS

*Projectors are ideal for showing reels of slides, and now, with the advent of digital technology, there are digital projectors that can read pictures from CD.*

use of technology is that under- or overexposed pictures can be easily corrected. Also, output from most digital SLRs—Fuji aside—tends to be quite neutral in color and contrast. There are camera settings that can alter this, but, if the output is neutral, it allows you to change the photos in a number of ways. Colors can be muted, enhanced for a vibrant look, or even removed completely for a black-and-white photo. Contrast can be reduced for a flat, even finish, or increased for a punchy, striking image. The power to manipulate pictures for exactly the right effect, and to produce different styles with the same picture, are all easily achievable on the computer.

Professionals tend to use Photoshop 7—not cheap at around \$600 (£400), but there are

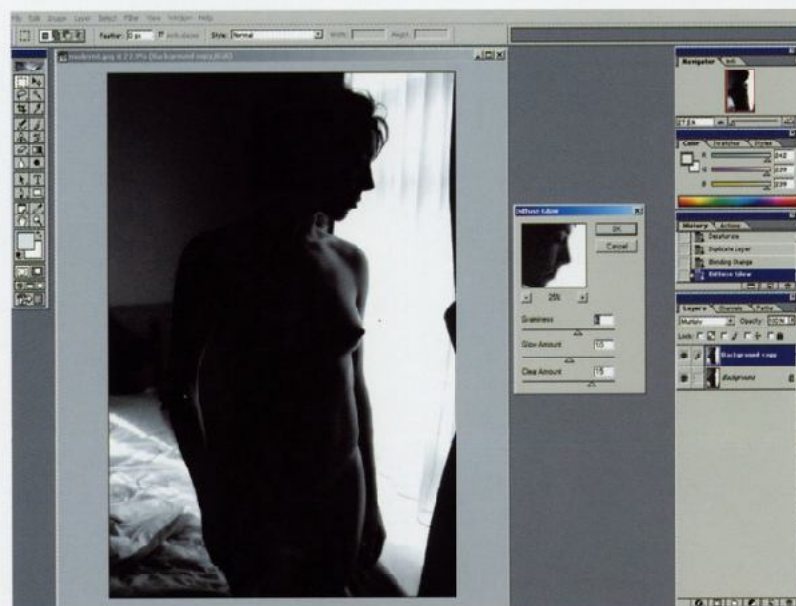

## SOFTWARE

*Photoshop can not only resolve the many flaws that appear in photographs, but can also substantially change the look and feel of digital images.*

inexpensive alternatives in the form of Paintshop Pro 7 (around \$60 [£40]), or a slightly cut-down version of Photoshop itself, in Adobe Photoshop (around \$120 [£80]). This latter program is excellent but does not have the CMYK support, the Pen tool, nor the quick masks of the larger product.

## PRESENTATION

Film transparencies are best viewed on a light box, a case with a sheet of opaque diffuser plastic over the top that contains two or more daylight-corrected fluorescent tube lights. The sheets of film can be placed on the top and then viewed through a magnifying glass.

If you do not have access to a light box, you can always suspend a sheet of plain paper over the bowl of a desk lamp and examine your slides against that. It is much easier for the digital photographer as pictures can be transferred from camera to computer by use of a memory-card reader and can then be examined on the spot. If you have your own studio, whether it is a professional setup or one at home, it can pay dividends to quickly assess the first session of a shoot on your computer. This way, if the photos are under- or overexposed due to unusually reflective or absorptive material, or the model has some flaw you didn't spot while shooting, then it

can all be corrected in the next session. When out on location, many digital photographers take a laptop computer with them, with a PCMCIA card that accepts IBM MicroDrives and CompactFlash cards, in order to proof the photos.



If you intend to sell the pictures, you must undertake a rigorous editing function. Anything that is out of focus, incorrectly exposed, badly composed, or visually unexciting should be thrown out. If you do not do this you will waste the time of your prospective purchaser, forcing him to sort through them instead. For the digital user the scrutiny can be less harsh because under- or overexposed photos can be easily restored if the lighting was not miscalculated by too much. A badly-composed photo is still not worth keeping—digital or not.

The images that pass your qualifying test should be mounted and filed in plastic sleeves in the case of film, or stored in specific folders on your hard drive in the case of digital. Large volumes of images from specific shoots can be backed up onto CD and indexed for later use. For slides, avoid using glass mounts, as if you have to send them through the post they may get broken. There is every

chance that the slivers of glass will irreparably damage transparencies as well as being unpleasant for the recipient. Glassless plastic mounts are the answer. If the pictures are filed in sleeves, the transparency surfaces should not come to any harm and will be easy to view.

It is very difficult to accurately assess the value of a set of pictures. The standard contract between photographer and picture buyer sets a figure for the loss of a picture, but that figure is related neither to the cost of producing the shot nor to any payment that may arise from it. If you are sending pictures by mail, you can safeguard yourself by registering the package or sending it by recorded delivery. The alternative for digital production is to see if the buyer has a fast e-mail or internet connection, as full-size images can be sent via broadband access. However, with ordinary 56K modems this would take far

## MEMORY CARD READER

*Transferring files from a digital camera to a computer is slow unless it is equipped with a finewire interface. A much better method is to use a card reader so that you can continue shooting on a new card while the contents of the first are being copied.*

too long, although smaller images in the form of JPEGs can be sent as a preview to show the type of work that you have to offer. Professionals often have their best pictures duplicated. They retain the originals and send out the duplicates. If a buyer likes the shots, the photographer can supply the originals. That way he only risks losing pictures when he has already made a sale. The drawback is that duplicating slides is time-consuming and fairly expensive. Digital users have more of an advantage because duplicating original files takes a couple of seconds and copies can be created with no loss of quality at all. Also, variations on images can be created to suit specific clients. If you are trying to sell your pictures on a speculative basis, remember that the prospective buyer is a busy person who is unlikely to want to look through hundreds of transparencies or prints. Never show him or her more than about 25 shots. If they are impressive, the buyer will ask to see more. You can then find out what sort of pictures are required and fit your submission to meet the buyer's needs.

Picture libraries vary in their requirements and can ask for anything from 100 to 500 transparencies from a new photographer. The larger and more general the library, the more shots they are likely to want. The smaller, more specialized library will accept fewer if the quality is good.



Date  
Photographer's name and copyright

File number  
Model and location

## TRANSPARENCIES

*Transparencies that you hope to sell should be captioned carefully, both for identification and to protect copyright (left).*

# INDEX

Figures in *Italics* indicate captions.

## A

Adams, Ansel 56  
 Adobe Photoshop 157  
 advertising 10, 14, 17, 22, 68, 82  
 aerial photograph 141  
 Agent Provocateur 26  
 air brushing 17  
 air release 102  
 Allerman, Dallas 46  
 angle of view 94  
 aperture settings 88, 97  
 Arroyo, Felice 49  
 Austin, Clive 7, 10-13  
 auto winder 99  
 Automatic White Balance (AWB) 97, 105, 107, 120

## B

backgrounds 141  
 backlighting 105, 111, 115  
 Bailey, David 96  
 Ballanchine 46  
 barn doors 117-18  
 beaches 132, 143  
 Berquet, Giles 62  
 black-and-white photography 6, 14, 17, 26, 62, 96, 97  
 body make-up 155  
 body painting 10  
 bracketing 110, 116, 117, 156  
 Brandt, Bill 28, 62  
 Brown, Leslie 46  
 Bullock, Sandra 61  
 burst mode 98

## C

cable release 100  
 cameras 10, 22, 26, 32, 36, 42, 62, 72, 88-91  
 35mm SLR 88, 88, 89, 90, 92, 96, 102, 115  
 care and maintenance on location 131  
 digital 89-91, 91, 96, 97, 98, 107, 117  
 medium- and large-

format 88-9, 88  
 view 89  
 Cameron, Julia Margaret 28  
 Carlos Clarke, Bob 7, 14-17  
*Shooting Sex* 17  
 censorship 20  
 center-weighted metering system 102, 103  
 Charged Couple Device (CCD) 91, 108, 108, 110, 113  
 checklists 85  
 Clergue, Lucien 6, 18-21, 34  
*Urban Nudes* 20  
 clip-test 156  
 clothes 143, 145, 145, 155  
 Cobb, Jan 6, 22-5  
 color 6, 7, 17, 22, 25, 26, 31, 57, 71, 75, 82, 90, 91, 96, 156  
 balance 89  
 temperature 96, 96, 105, 107  
 coloramas 10  
 Colour Studios 26  
 CompactFlash cards 157  
 composite photographs 13, 137  
 composition 138-47  
 abstract shapes 145-6, 147  
 backgrounds and foregrounds 141  
 clothes and props 143, 145, 145  
 composing the image 138  
 using locations 141, 143  
 viewpoint 138, 141, 141, 147, 150  
 computers 10, 22, 25, 26, 61, 62, 68, 155-7  
 Connolly, Billy 72  
 Conran, Sir Terence 75  
 Contax 91  
 continuous shooting 99  
 contrast 116, 156  
 contre jour 113  
 Cox, Gilbert 36  
 cropping 90  
 Cunningham, Imogen 56

## D

Delves-Broughton, Emma 7, 26-31  
 depth of field 88

differential focusing 141  
 diffusion 110-11, 113, 118, 120, 138  
 digital correction 156-7  
 digital photography 6, 10, 13, 18, 22, 26, 32, 41, 42, 52, 55, 61, 62, 89-91, 96, 97, 98, 105, 107, 108, 138, 156, 157

## E

Ektachrome 64 96  
 exposure values 102

## F

fantasy 14, 17, 51, 68  
 Farber, Robert 6, 32-5  
*Farber Nudes* 32  
*Images of Women* 32  
*Professional Fashion Photography* 32  
 fetishism 6, 42, 51, 144  
 film choice 89, 96-7, 96  
 filters 96, 105, 105, 107, 107, 138  
 "fish fryer" 118-19, 119  
 flash 104-5, 104, 117-19, 120  
 fill-in 122-3, 123  
 flash gun 98, 104-5, 104, 122, 123  
 focal length 91, 92, 92, 94, 94, 95  
 foregrounds 141  
 form 6, 20, 22, 25, 35, 71  
 F.Stop gallery, Bath 26, 28  
 Fuji 89, 96  
 Fujifilm 96, 96

## G

*Glamour Girl* catalog 26, 28  
 Gothamstock 25

## H

hand-tinting 14, 17, 26  
 Hayak, Salma 61  
 Holmes, Nigel 7, 36-41  
 House of Harlot, London 42  
 humor 6, 68, 68, 136  
 Hurrell, George 32

## I

IBM MicroDrives 157  
 ISO rating 156

## J

Joom 59

## K

Kahn, Louis 46  
 Kaz Studio 13  
 Kelly, John 117  
 Kern, Richard 46  
 Kertez, André 28, 56  
 Klaw, Irving 46, 46  
 Klaw, Paula 46, 46  
 Kodachrome 96, 96  
 Kodak 89, 91, 96  
 Krider, Chas Ray 42-5  
 Kroll, Eric 6, 46-51  
*Elmer Batters. From The Tip of The Toes to The Bottom of The Hose* (ed.) 48  
*Eric Kroll's Naughty and Nice* 49  
*Fetish Girls* 46

## L

LaChapelle, David 7  
 Latin Shoes of London 10  
 Latriques, Henri 32  
 lens hoods 115  
 lenses 92-5  
 choosing 92, 92, 94, 94  
 wide-angle 68, 95  
 zoom 92, 94-5  
 Lichfield, Patrick 7, 52-5, 91  
 light box 157  
 light meter 88  
 lighting 6, 22  
 back/side 55  
 bright 10, 17  
 dramatic 32, 35  
 filtered 85  
 flash 10, 12, 18, 22, 24, 26, 28, 31, 46, 49, 65, 68, 70, 71  
 natural 26, 31, 32, 34, 36, 41, 46, 49, 52, 66, 71, 108, 136

- rim 83  
 simple 14  
 single source of 41  
 strong 10  
 subtle 36, 116
- lighting conditions 108-23  
 artificial lighting 117  
 changing positions of  
 the sun 113  
 diffusion 110-111, 113  
 direct overhead sunlight  
 108, 110, 110, 111  
 early morning 108, 108  
 electronic flash 117-9,  
 120  
 evening 108, 108  
 fill-in flash 122-3, 123  
 flare 115  
 mixed light sources  
 121-2  
 natural light indoors  
 116-17  
 reflectors 115-16  
 shooting into the sun  
 113  
 tungsten lighting 12, 18,  
 57, 68, 72, 75, 96, 97,  
 105, 117, 119, 120-21
- location shooting 84-5, 84,  
 128-37  
 camera care and  
 maintenance 131  
 improvised locations 136  
 interior locations 131,  
 133, 135, 135  
 outdoor locations 128,  
 128, 130-31, 130
- Lynch, David 42
- M**
- make-up 154, 155  
 body 155  
 Man Ray (Emmanuel  
 Radnitsky) 10, 28, 46  
 Mapplethorpe, Robert 56  
 Marcus, Ken 56  
 memory cards 153  
*Men Only* magazine 36  
 meters 102, 102, 103, 104  
 Midori 56, 61  
 model agencies 86  
 model-release forms 86, 87  
 models 148-55  
 assessing a model 150,  
 150, 153  
 choosing 85-6  
 cropping head 20, 20, 34  
 model/photographer  
 relationship 13, 18, 28, 72,  
 148, 150  
 new/established 10  
 posing 152, 153-5  
 professional/amateur 17,  
 22  
 testing 52
- Mollnere, Horst 46  
 Mollnere, Pierre 46  
 montage 14, 17  
 Morey, Craig 6, 56-61  
*I Am My Lover* 61  
*Studio Nudes* 61  
 Morey, Craig and Midori:  
*The Seductive Art of  
 Japanese Bondage* 56,  
 61  
 Motel Fetish style 42, 44  
 motor drives 98, 98, 99
- N**
- negatives 96  
 Newman, Byron 10, 135  
 Newton, Helmut 26, 28, 42
- O**
- One Model Place* 86  
 overexposure 34
- P**
- Palk, Nam June 46  
 Paintshop Pro 7 157  
 Parkinson, Norman 28  
 PCMCIA card 157  
*Penthouse* 32, 56, 58, 59, 61  
 "Erotic Dancer" series 59  
*Penthouse Letters* 56  
 photographic equipment  
 accessories 98-107  
 cameras 88-91  
 film 96-7  
 lenses 92-5  
*Photography World* 86  
 Photoshop 24, 85, 107, 137,  
 138, 156-7  
 picture libraries 157  
 Pigalle 26, 28  
 polarizing filters 107  
 Polaroids 22, 61, 89, 152  
 Portman, Natalie 61  
 posing 152, 153-5  
 post production 156-7  
 presentation 157  
 projectors 156  
 props 143, 145, 145, 148  
 Provia 96
- R**
- Recontres Internationales  
 de la Photographie 18  
 rectangular film formats  
 89, 90  
 red-eye effect 123  
 reflections 13, 28, 31, 41, 55,  
 104, 107, 120  
 reflectors 115-16, 117, 117,  
 132  
 remote releases 100, 102,  
 102  
 roughs 82, 84  
 RPS gallery, Bath 28
- S**
- San Francisco  
 Camerawork 56  
 sea, shooting towards the  
 132  
 sets 10  
 shadow 6, 12, 75, 103, 110,  
 110, 111, 113, 115, 117,  
 118  
 sharp focus 88  
 shutter speeds 80, 88, 97,  
 98, 122  
 silhouette 10, 113  
 Siskind, Aaron 56  
 slow film 96, 97  
 Smith, Eugene 46  
 snoots 39  
 soft focus 35, 105  
 softboxes 10, 28, 46, 48, 51,  
 57, 62, 118  
 software 156-7, 156  
 special-effects filters 105,  
 107  
 spot metering 102, 104  
 spotlighting 10, 106, 118  
 square format 90  
 Stiechen, Edward 32  
 studio shooting 84, 124-5,  
 127  
 Supadance Ballroom 10  
 Suschitsky, Wolf 10  
 "swimming pool" 119, 119
- synchro-sunlight see flash,  
 fill-in
- T**
- test shots 86, 150  
 theme, choosing a 80, 82-4  
 transparencies 96, 157, 157  
 tripod feet 101  
 tripods 88, 98, 100, 100, 101,  
 116, 117
- U**
- Unipart calendar 7
- V**
- Vargas 152  
 Velvia 96  
 Viva 32  
 Von Tease, Diuta 42
- W**
- water, shooting in 132, 143  
 Watson, Trevor 6-7, 62-7  
*Exposed* 62  
*Kink* 62  
 Wedge, James 135  
 Weston, Edward 56  
 Westwood, Ben 7, 68-71  
 Westwood, Vivienne 68  
 wide-angle lens 68, 95, 147  
 Willie, John 46, 51, 62
- Y**
- Yerbury, Trevor and Faye 6,  
 72-7  
*Victoria's Summer* 75  
 Yvonde, Madam 28
- Z**
- zone (matrix) metering  
 system 102  
 zoom lens 92, 94-5



# ACKNOWLEDGEMENTS

Quarto and the author would like to thank the following for supplying pictures reproduced in this book.

Clive Austen 10-13 ([www.kaz-studio.co.uk](http://www.kaz-studio.co.uk))  
Bowens International 104l  
Canon UK 91tr  
Bob Carlos Clarke (Internet orders to: [www.shootingsex.com](http://www.shootingsex.com) Telephone orders: +44 (0)1564 795745) 14-17  
Lucien Clergue 18-21  
Jan Cobb ([www.gothamstock.com](http://www.gothamstock.com)) 8c, 22-25. Contax/Calumet 92cr  
Emma Delves-Broughton 2, 4t, 8tc&cr, 26-31 ([www.emmadelvesbroughton.com](http://www.emmadelvesbroughton.com))  
Duncan Evans 86/87all, 100, 107all, 115, 116f, 137all  
Robert Farber 32-35 ([www.photoworkshop.com](http://www.photoworkshop.com))  
Fuji Photo Film 96 b, 153 b  
Nigel Holmes 4c&b, 8c&bc, 36-41, 78all, 80/81, 83all, 90all, 93tl, 94l, 97t, 99l, 103all, 106, 108/109all, 110t, 111b, 112, 114, 118/119all, 120/121all, 122/123c, 124b, 126/127all, 132c, 133, 136all, 138/139, 144t&bl, 151, 154all ([www.girifiles.co.uk](http://www.girifiles.co.uk))  
Intro 2020/Silk 101 tl, cl, cr  
Jessops 100 b (Mantrip), 104 r  
Johnsons Photopla/Sekonic 102 c  
John Kelly 89, 91tl, 93 c&bl&br, 110b, 111t, 116bl, 116/117bc, 122l, 124t, 128, 132tl&tr&b, 141, 143tr, 148/149, 150  
Kodak 153 t  
Kodak Professional 91 br  
Chas Ray Krider 8tl&br, 42-45 ([www.motelfetish.com](http://www.motelfetish.com))  
Eric Kroll 3, 46-51 ([www.fetish-usa.com](http://www.fetish-usa.com))  
Lelca 156 t  
Patrick Lichfield 52-55  
Mamiya 88 b  
Manfrotto 100-101, 101 tc, tr, c  
Minolta 88 t  
Craig Morey 56-61 ([www.moreystudio.com](http://www.moreystudio.com))  
Byron Newman 134/135 (reproduced by kind permission of Lui magazine)  
Nikon 98  
Pentax/Calumet 92 c  
Sigma 91 cr  
Chris Thompson 82all, 84/85, 93cl&tr, 94/95c, 95r, 97b, 99r, 105all, 129, 130/131, 140, 142b, 142/143tl, 144/145c, 145t, 146/147all, 152all, 155b  
Trevor Watson 1, 62-67.  
Ben Westwood 8bl&c&tr, 68-71 ([www.benwestwood.com](http://www.benwestwood.com))  
Trevor and Faye Yerbury 72-77 ([www.yerbury.net](http://www.yerbury.net)).

Key: b=bottom, t=top, c=center, l=left, r=right

All other photographs and illustrations are the copyright of Quarto Publishing plc. While every effort has been made to credit contributors, we would like to apologize in advance if there have been any omissions or errors.



# CLASSIC GLAMOUR PHOTOGRAPHY

Find out how the professionals achieve their results with examples of their work and details on locations, models and equipment used.

Get clear, practical advice on choosing the right equipment and working with models.

Learn all about lighting, shooting in a studio or on location, composition, post production and the latest digital techniques.

ISBN 1-902538-31-5



9 781902 538310 >

Printed in China